

HELL—OO FROM
THE ABYSS

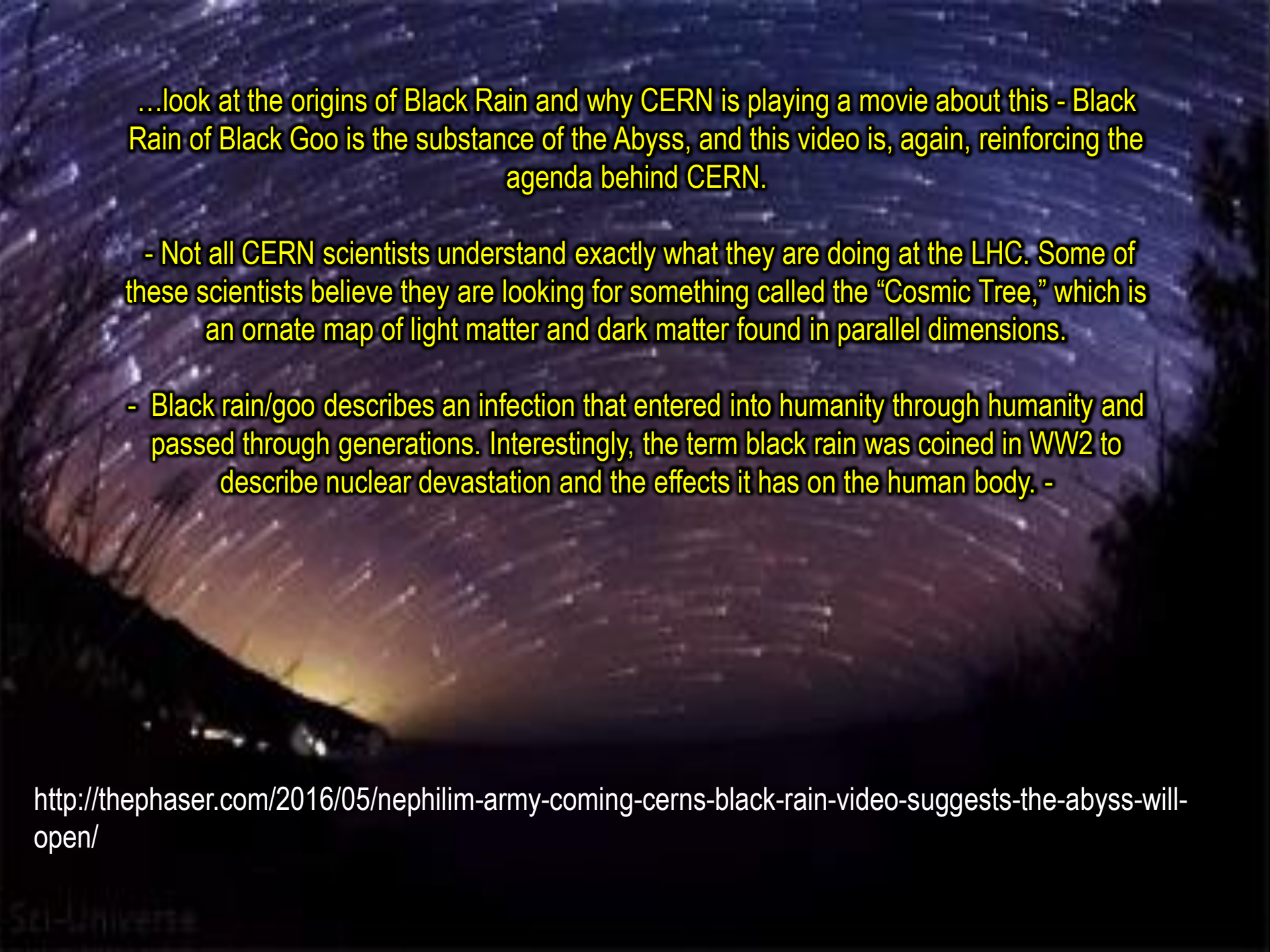

Enoch 18:11-12 And I saw a great abyss in the earth, with columns of heavenly fire; and I saw among them columns of heavenly fire which fall, and are without number, either towards the height or towards the depth. And over the abyss I saw a place which had no firmament of heaven above it , and no foundation of earth beneath it, and no water above it, and no birds upon it; it was a void place.



...look at the origins of Black Rain and why CERN is playing a movie about this - Black Rain of Black Goo is the substance of the Abyss, and this video is, again, reinforcing the agenda behind CERN.

- Not all CERN scientists understand exactly what they are doing at the LHC. Some of these scientists believe they are looking for something called the “Cosmic Tree,” which is an ornate map of light matter and dark matter found in parallel dimensions.
- Black rain/goos describes an infection that entered into humanity through humanity and passed through generations. Interestingly, the term black rain was coined in WW2 to describe nuclear devastation and the effects it has on the human body. -

<http://thephaser.com/2016/05/nephilim-army-coming-cerns-black-rain-video-suggests-the-abyss-will-open/>

Welcome To Hell: The Giant Fort McMurray Fire Is The Worst Blaze In Canadian History

Posted on May 8, 2016 by Michael Snyder

<http://www.dcclothesline.com/2016/05/08/welcome-to-hell-the-giant-fort-mcmurray-fire-is-the-worst-blaze-in-canadian-history/>



“It was something like Armageddon,” said Morgan Elliott, who traveled with his fiancée, Cara Kennedy, and their baby, Abigail. “Everything was burnt, houses gone. Leaving the city, it was like a scene out of a movie. It reminded me of the TV show ‘The Walking Dead’ where you’re going on the highway, and there’s just abandoned vehicles everywhere; hundreds of cars, just abandoned vehicles.”



<https://www.youtube.com/watch?v=ieTQvldG-Vo>

But let us not forget that 2015 was the worst year for wildfires in all of U.S. history. Last year more acres burned in the United States than we had ever seen before, and 2016 is already shaping up to be another very bad year.

In fact, according to the National Interagency Fire Center we are already more than a million acres ahead of the pace that was set last year.

I just checked the U.S. Drought Monitor and much of the western third of the country is still extremely dry. Conditions are certainly ripe for another horrible wildfire season, and so let us pray for lots of rain between right now and the end of the summer.



Though denied by HAARP project officials, some respected researchers allege that secret electromagnetic warfare capabilities of the project are designed to forward the US military's stated goal of achieving full-spectrum dominance by the year 2020.

Others go so far as to claim that HAARP can and has been used for weather control, to cause earthquakes and tsunamis, to disrupt global communications systems, and more.

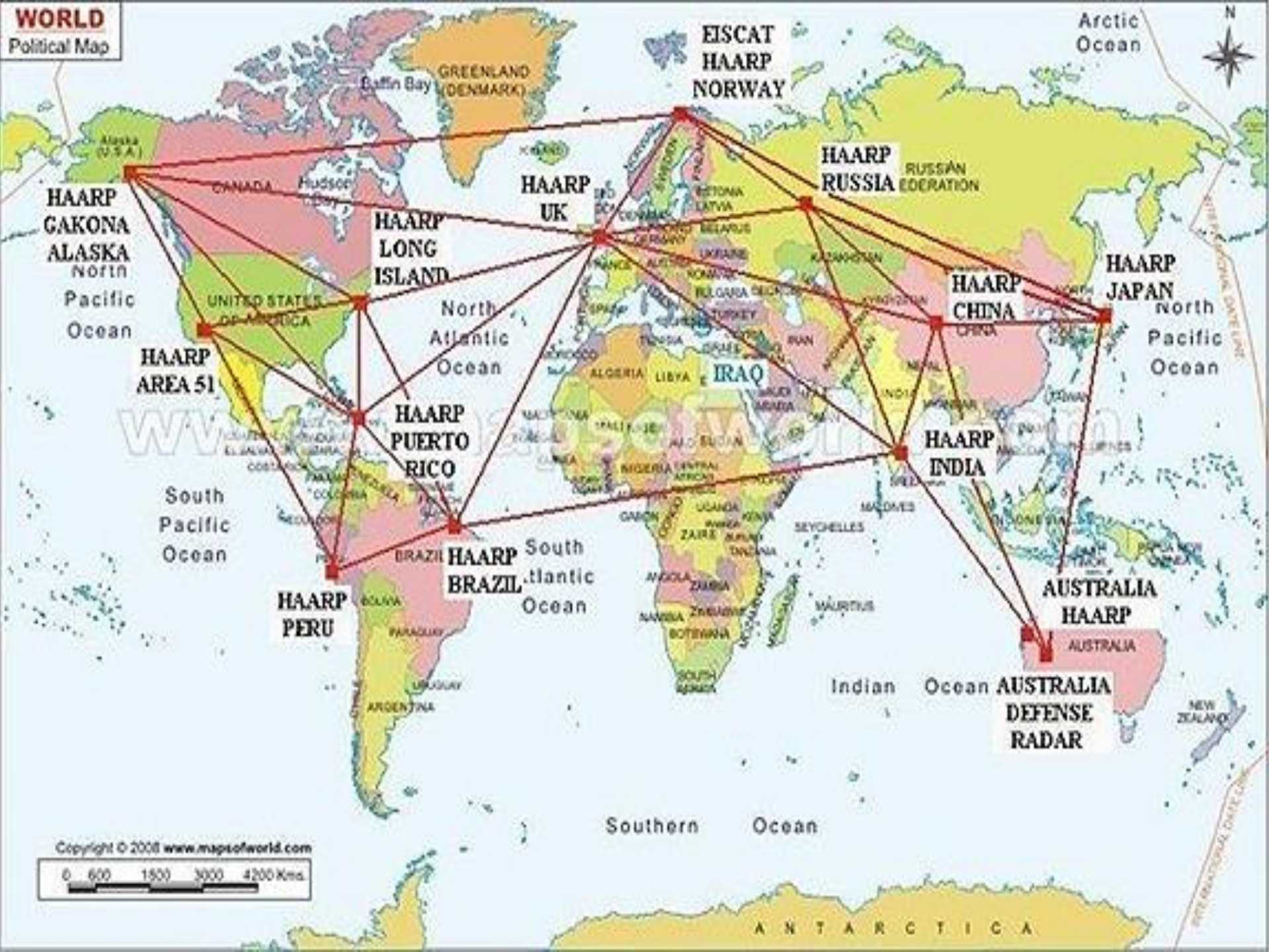

HAARP (High Frequency Active Auroral Research Program) is a little-known, yet critically important U.S. military defense project which has generated quite a bit of controversy over its alleged weather control capabilities and much more.

It's being said that this year will be the hottest, driest year, 2016..and they claim this is due to CLIMATE CHANGE, no longer using GLOBAL WARMING. And here we have one of the worst fires that they have no idea when it will be contained or end. Coincidence?? The adversary is going to use EVERYTHING to enslave, but the only thing that will happen, is he will bring on HIS end quicker.

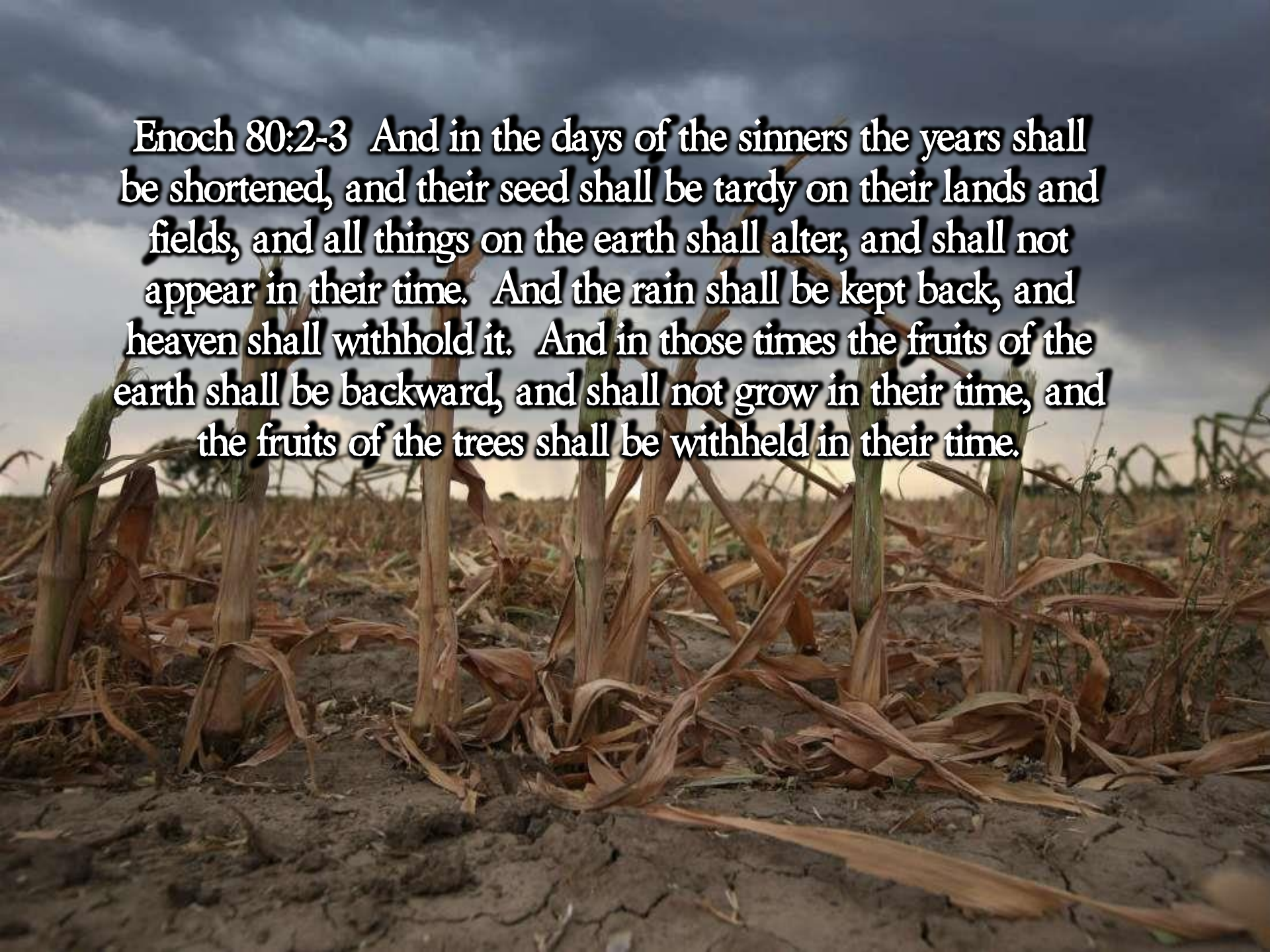

Enoch 80:2-3 And in the days of the sinners the years shall be shortened, and their seed shall be tardy on their lands and fields, and all things on the earth shall alter, and shall not appear in their time. And the rain shall be kept back, and heaven shall withhold it. And in those times the fruits of the earth shall be backward, and shall not grow in their time, and the fruits of the trees shall be withheld in their time.



Rev 11:6 These have, possess the ability to hold the authority, power and control over and shut up the shamayim , in order and so that the sky/shamayim it does not rain during and for an indefinite amount of time during the days of their prophetic utterances. And they have the authority, power and control over waters, to change the characteristic to turn them to blood, and to afflict suddenly and adversely and strike a blow to the earth with every and in total plague and distress as often as they desire.

Mat 24:7-8 For nation will rise up against nation and kingdom against kingdom, and there will be famines, violent starvation and earthquakes in various places. But all these things are beginning of birth pangs, agony and great suffering.

Isaiah 5:14

לָכֵן הִרְחִיבָה שְׂאוֹל נַפְשָׁהּ וּפְעֵרָהּ פִּיהָ
לְבַל־יִחַק וַיֵּרֵד הַדָּרָה וְהַמִּוֶּנֶה וְשִׂאוֹנָהּ
וְעֵלְזָהּ בָּהּ: | LEB OT RI her. | LEB

Therefore Sheol, the grave, the realm of death has enlarged, broaden and widened its breath, soul and desire, and it has opened wide its mouth, taste and hunger without limit cessation or boundary, regulation or share, and her nobles will descend and be bought down, and her multitude, wealth and abundance, her tumult and uproar and those who revel and exalt in Sheol and death.



**Human extinction risks: people more likely to die
in an extinction event than a car crash**

CBS
NEWS
CBSNEWS.COM

WORLD : Major Volcanoes



Mexico's Popocatepetl Volcano at high risk for exploding

Posted on [April 9, 2016](#)

Mexico's Popocatépetl comes to life at 2:30 in the morning with massive explosion – hurls ash over nearby town

Posted on [April 19, 2016](#)



April 2016 – MEXICO – Mexican authorities are warning of the potential for major activity at an active volcano just 50 miles southeast of Mexico City. Experts on the Popocatepetl Volcano issued the warning Wednesday after observing an increased level of explosive activity in recent months. In the last two weeks alone, the volcano has exploded on several occasions resulting in the expulsion of gases and smoking, fiery fragments. Authorities are carrying out flyovers to inspect the crater with the support of the federal police, experts, and civil protection authorities.



Alaska's Pavlof Volcano settles down after late March eruption

by [The Extinction Protocol](#)



Two Mexican volcanoes are erupting

by [The Extinction Protocol](#)



April 2016 – **MEXICO** - Popo and Colima might sound like characters in a children's show. But they're actually two big Mexican volcanoes that are erupting right now, and sending mile-high columns of ash and soot into the sky. Mexico's coordinator of Civil Protection of the Ministry of the Interior, Luis Felipe Puente, tweeted on Tuesday that Popo — full name





Location of Volcanos in the United States

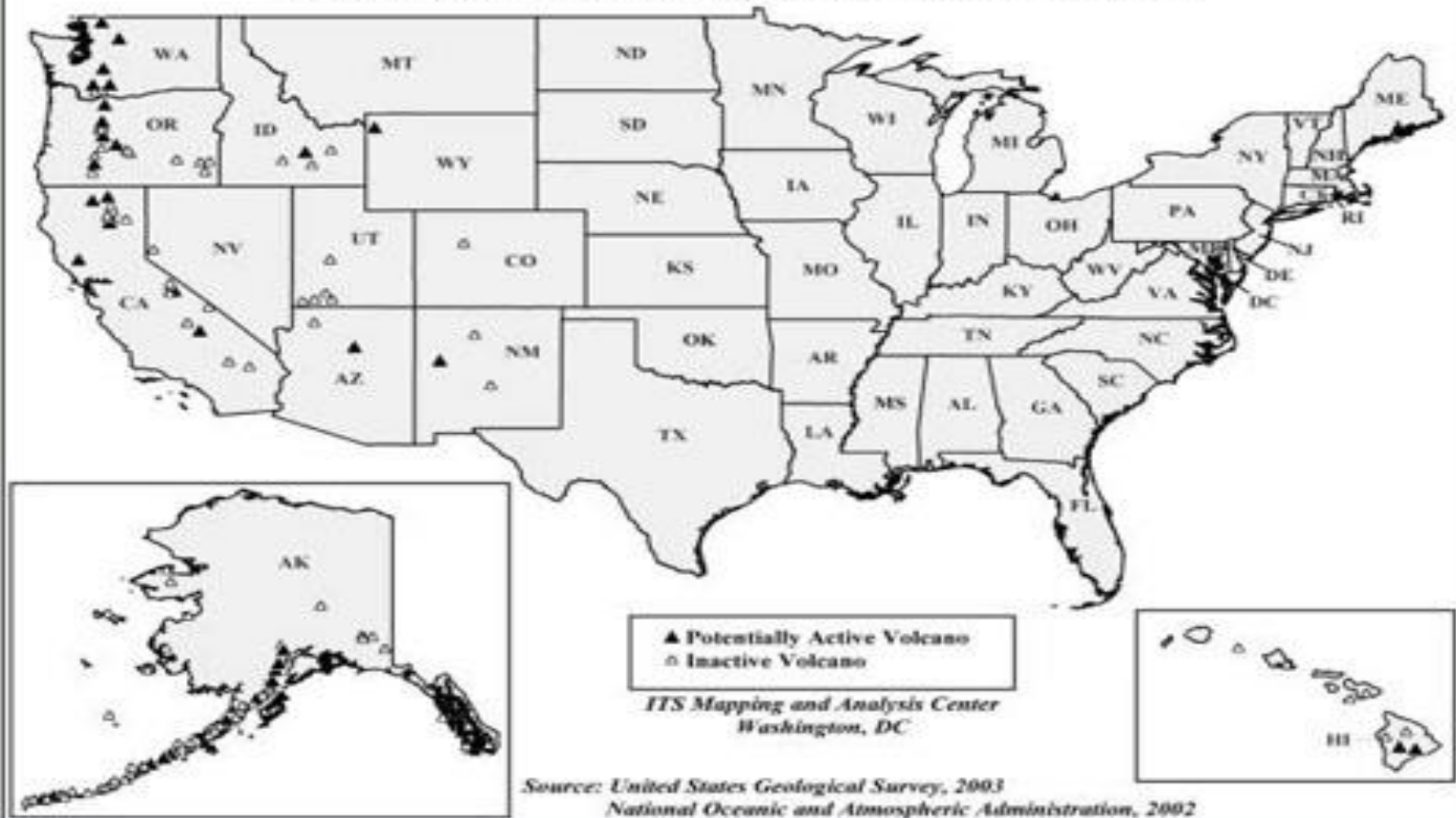

ICELAND VOLCANOES AND GLACIERS

Grimsvotn volcano

- **Type** Caldera volcano
- **Summit elevation** 1,725m
- **Last explosion** 2004
- **Location** Lies under the Vatnajokull glacier, the largest in Europe
- **Activity** Current eruption is the most violent at the volcano since 1873

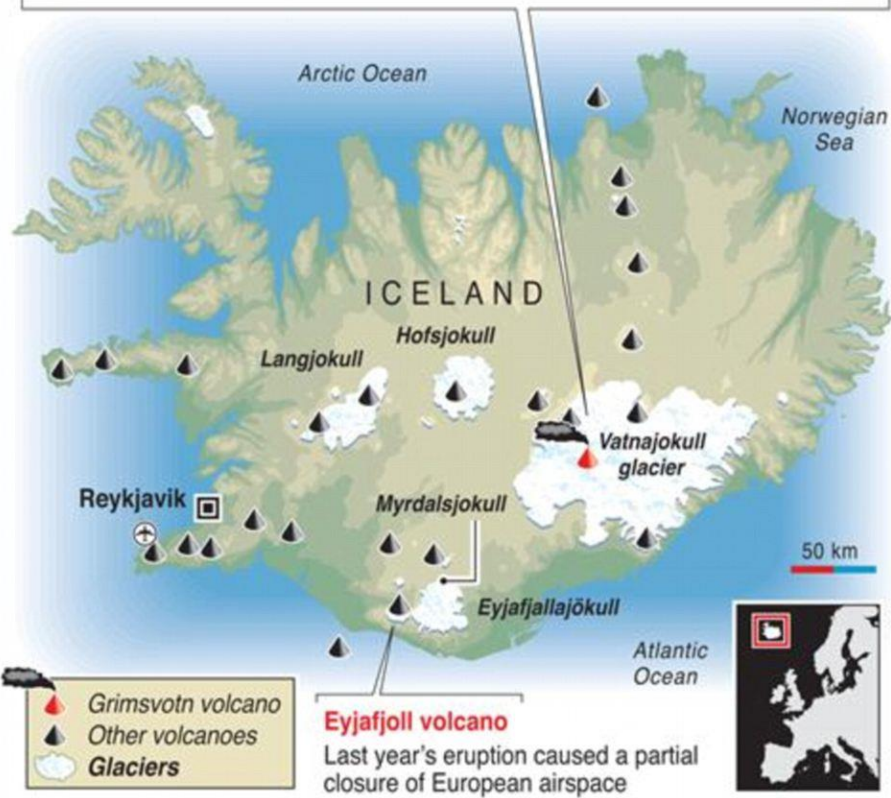

Sources: www.volcanolive.com, www.volcano.si.edu

REUTERS

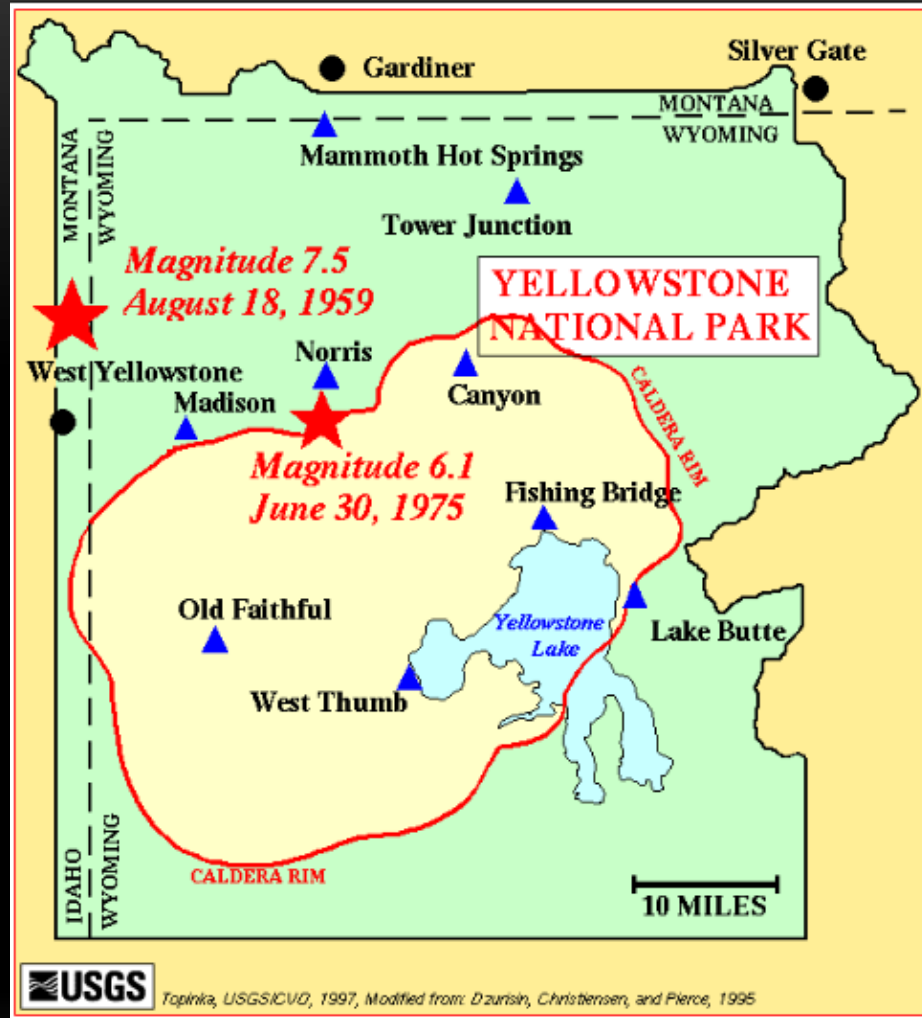



Possible Yellowstone Supervolcano Eruption

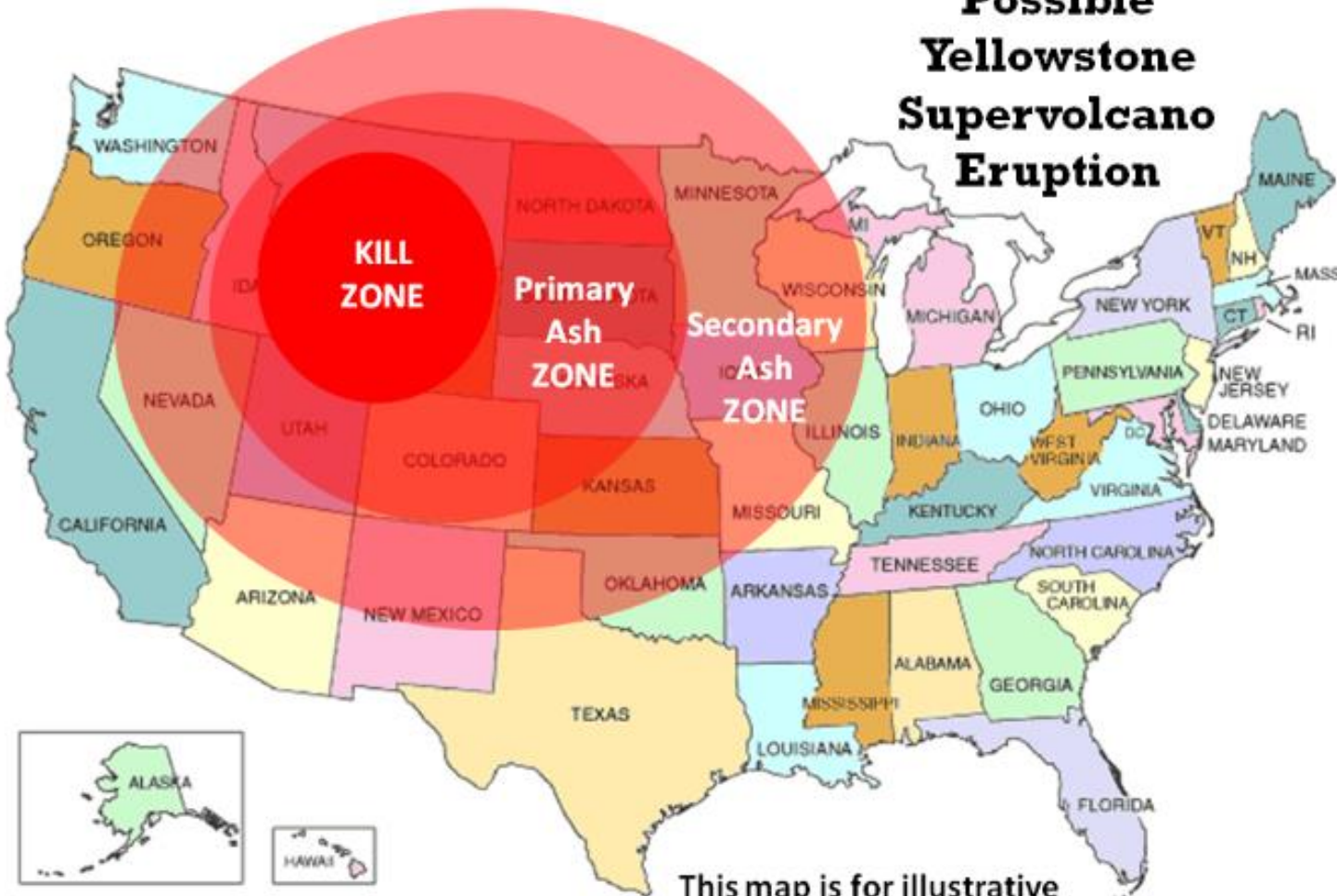

This map is for illustrative purposes only. If the supervolcano erupts the exact zones will depend on wind, time of year, and other factors.



Major Volcanoes of Japan



Topinka, USGS/CVO, 1996; basemap modified from:
CIA map, 1997; volcanoes from: Simkin & Siebert, 1994



Massive volcano in North Korea may be waiting to blow

by [The Extinction Protocol](#)



10 Vile Vortices around the World

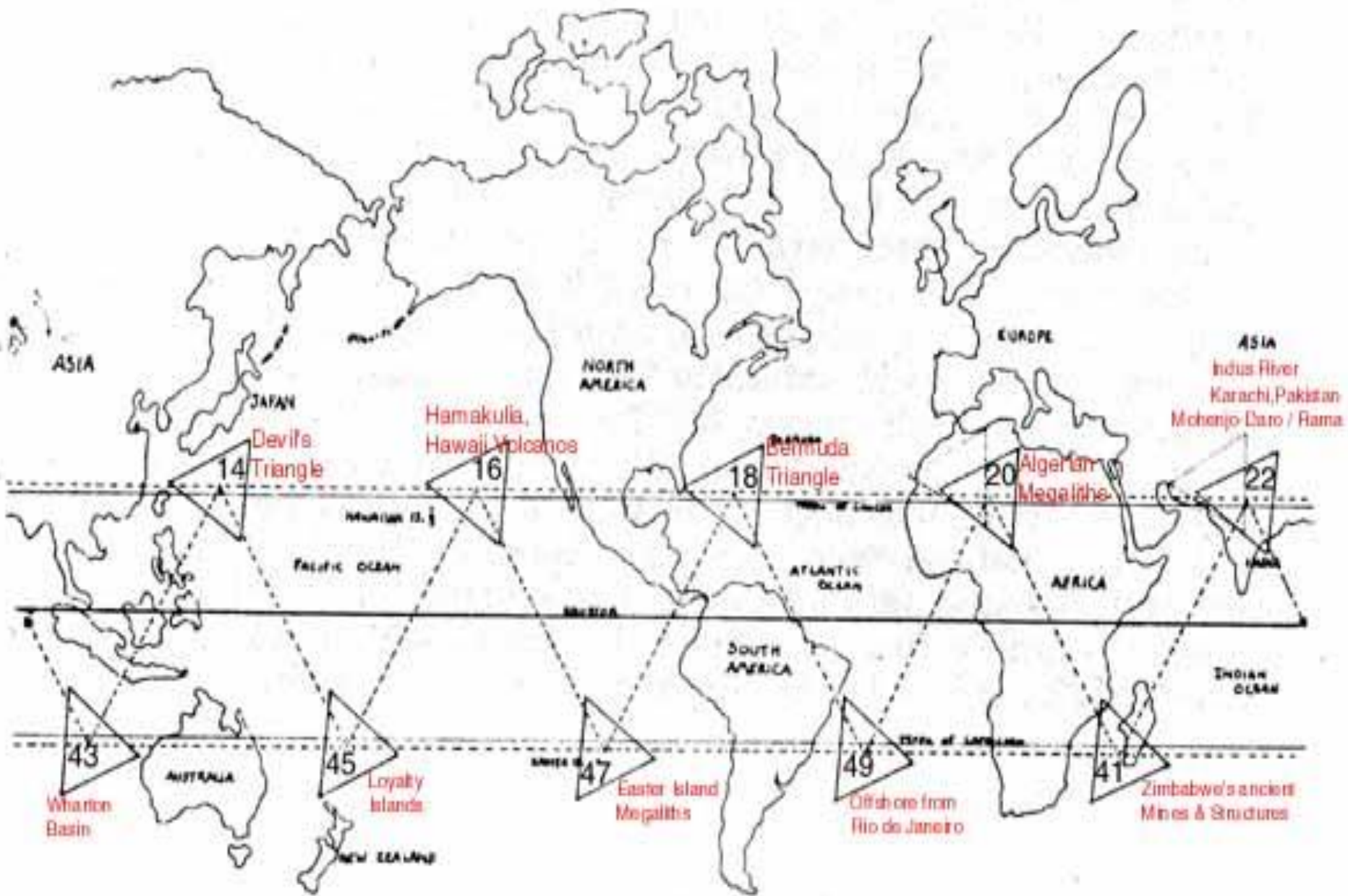

"A vortex is a mass of energy that moves in a rotary or whirling motion, causing a depression or vacuum at the center.... These powerful eddies of pure Earth power manifest as spiral-like coagulations of energy that are either electric, magnetic, or electromagnetic qualities of life force."

Thus said, Vortexes are areas of high energy concentrations, originating from magnetic, spiritual, or sometimes unknown sources. Additionally they are considered to be gateways or portals to other realms, both spiritual and dimensional. Vortexes typically exist where there are strong concentrations of gravitational anomalies, in turn creating an environment that can defy gravity, bend light, scare animals, twist plant life into contorted shapes, and cause humans to feel strange. Many vortexes have been shown to be associated with Ley Lines and have been found to be extremely strong at node points where the lines cross. **Worldwide, the Great Pyramid in Egypt and Stonehenge in England are perhaps the most well known as centers of vortex activity, lesser known the Gog and Magog Hills.**

Besides the worldwide sites mentioned above there are quite powerful vortexes in the United States. The most notable being the Oregon Vortex, Mount Shasta Vortex, and the four Sedona, Arizona vortexes. Superstition Mountain, Arizona is also the home of vortexes. However, unlike the previous three which are more or less permanent, easily sought out and experienced by crowds of tourists, lay persons, and New Agers, the vortexes in the Superstition Mountains, although equally as powerful or maybe even more so, are much more mysterious, subtle, and depend on the coming together of certain, but not always known to all, conditions (see). Also considered by some as vortex hot spots, and coincidentally, ALL in Arizona for some reason, are certain areas of the Grand Canyon, Sunset Crater, and the 50,000 year old meteorite impact site known as Meteor Crater.

'Ley lines are hypothetical alignments of a number of places of geographical interest, such as ancient monuments and megaliths. Their existence was suggested in 1921 by the amateur archaeologist Alfred Watkins, whose book 'The Old Straight Track' brought the alignments to the attention of the wider public'.

Ley Markers -The following natural and man-made features were suggested by Watkins to be reliable ley-markers:

Mounds, Long-barrows, Cairns, Cursus, Dolmens, Standing stones, mark-stones, Stone circles, Henges, Water-markers (moats, ponds, springs, fords, wells), Castle, Beacon-hills, Churches, Cross-roads, Notches in hills, Camps (Hill-forts), Any true Watkinsian ley requires it to have a start (or finish) point in the shape of a hill. (4)

From map and fieldwork, Paul Deveraux concluded that all Henges are likely to indicate the presence of a Ley. (2)

• Astronomical Alignments:

The fact it took so long for us to realise that astronomy was in any way involved with megalithic culture is almost as surprising as the fact that it was ever forgotten. Although there has been a traditional resistance to this theory from the scientific establishment, we live in a time when it is finally accepted that many of the larger megalithic constructions were designed so as to be able to accurately identify celestial objects or measure their cycles.

The clear link between megaliths and astronomy can also be said for megaliths and ley-lines, as they are often found to be prime ley-markers, and intersections of several ley-lines (i.e., [Arbor-Low](#), [Avebury](#), [Stonehenge](#) etc).

One of the largest Leys in England, the so-called [St. Michaels Ley](#), is aligned along the path of the sun on the 8th of May (The spring festival of St. Michael) and can therefore be considered astronomical. This line passes through several megalithic sites before it reaches [Glastonbury](#), (artificially shaped to follow the direction of the ley), and then on to the Avebury/Silbury complex, both significant English landscape features.



The St. Michael's Leyline follows the path of the Sun on the 8th May (The spring festival of St. Michael).

Active Volcanoes, Plate Tectonics, and the "Ring of Fire"

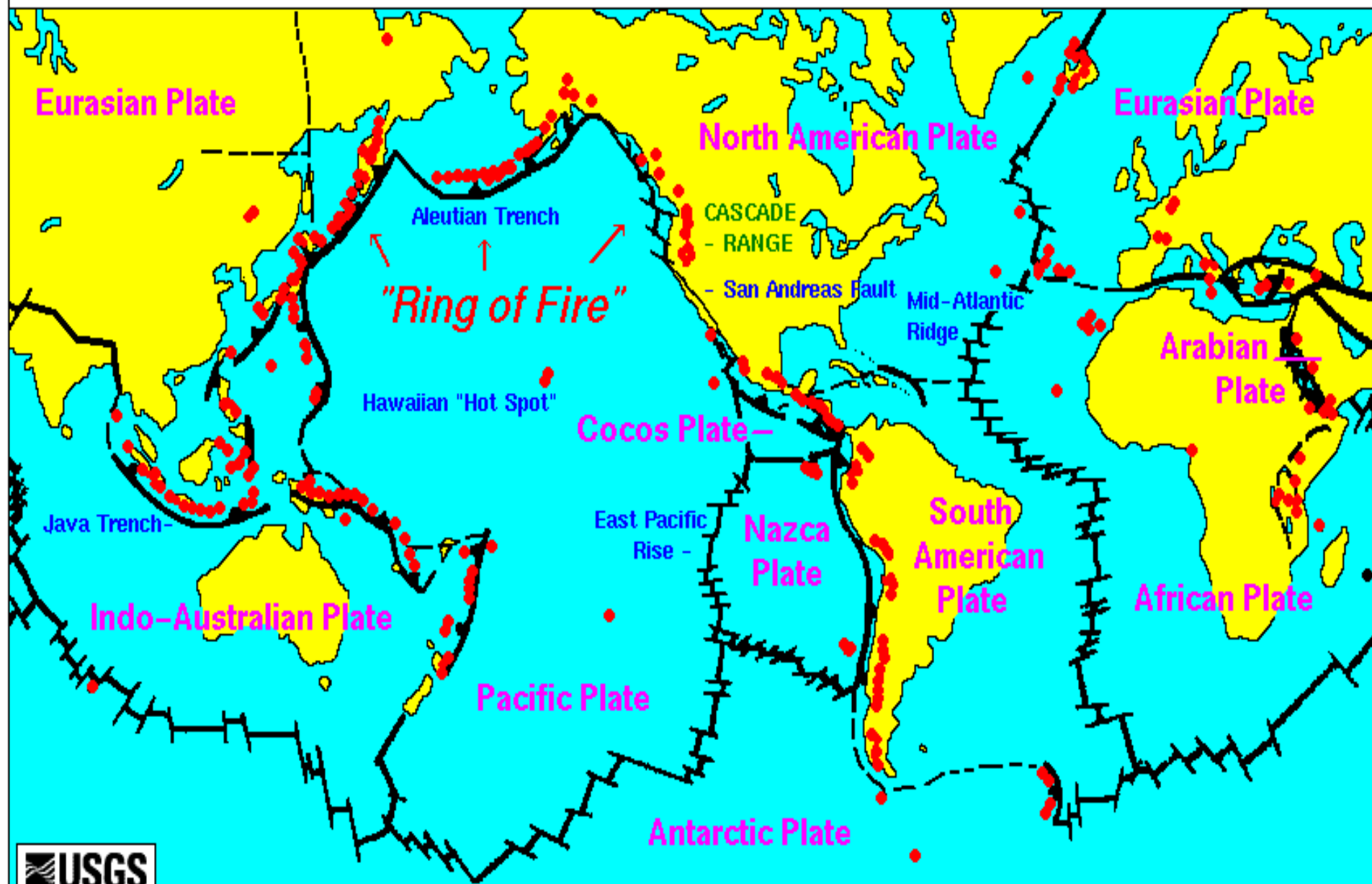

Volcanoes and earthquakes go hand in hand – especially in the Ring of Fire:

6.9 magnitude quake strikes western Myanmar, shakes neighboring countries

Posted on [April 14, 2016](#)

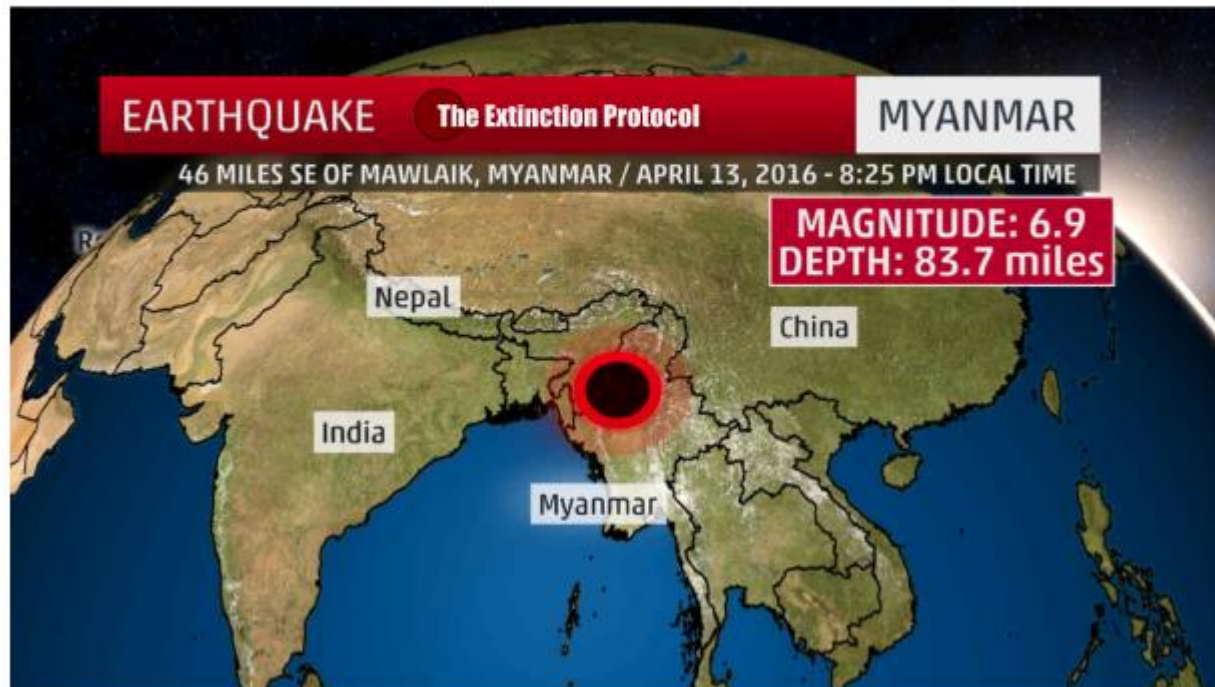

Strong earthquake kills 9, injures more than 800 in Japan

Posted on [April 16, 2016](#)

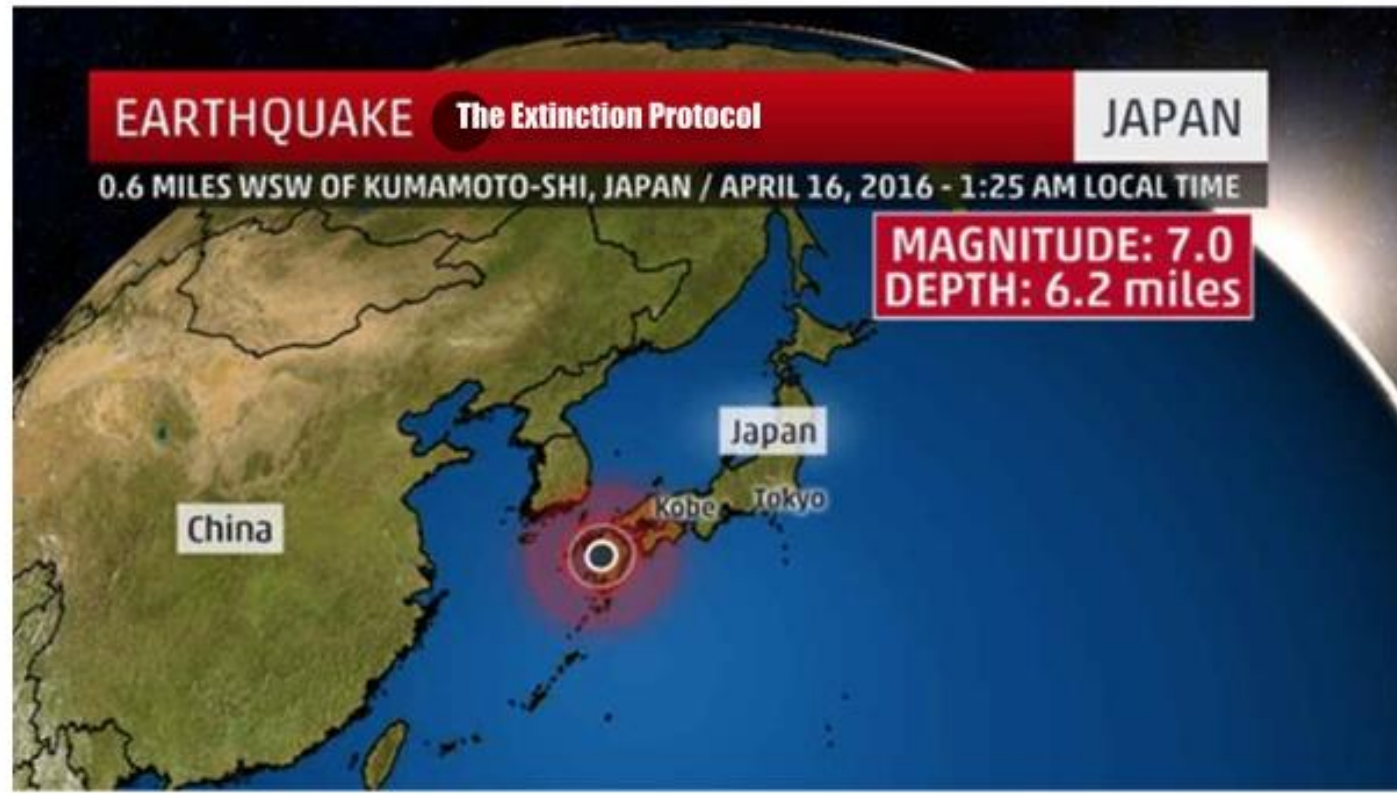

Big earthquake hits off coast of Guatemala

Posted on [April 16, 2016](#)



April 2016 – **GUATEMALA** – A **6.2** magnitude earthquake that hit off the coast of Guatemala Friday

413 dead after 7.8-magnitude earthquake hits near Ecuador's coast – where will the next big quake strike?

Posted on [April 17, 2016](#)

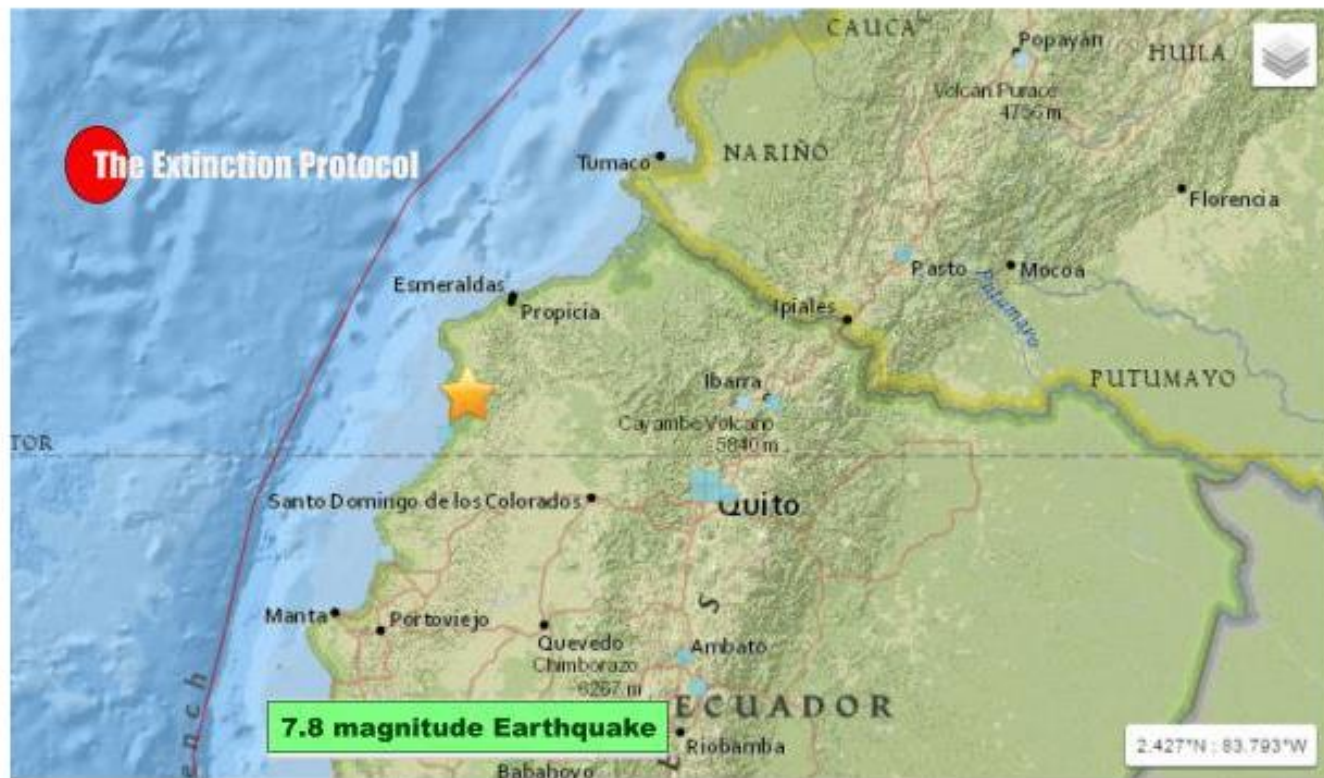

News Room April 29, 2016

Today's 7.0 Earthquake Literally Shook the Entire Planet; registered throughout entire USA!

Today's magnitude 7.0 earthquake was so ferocious, it literally shook the entire planet DURING – and upwards of 20 minutes AFTER – striking Vanuatu on the other side of the world! According to the US Geological Survey, ALL EIGHTY-EIGHT SEISMOGRAPHS in the the Advanced National Seismic System (ANSS) registered the massive quake over ten thousand miles away! Moreover, the ANSS also registered continued shaking traveling through the planet for upwards of twenty-minutes AFTER the quake ended! So forceful and violent was this earthquake, that its shock waves actually registered on every seismograph in the USA; even sending some of the US Seismographs **right-off-the-scale** !!! It even shook the **Yellowstone Super-Volcano!**

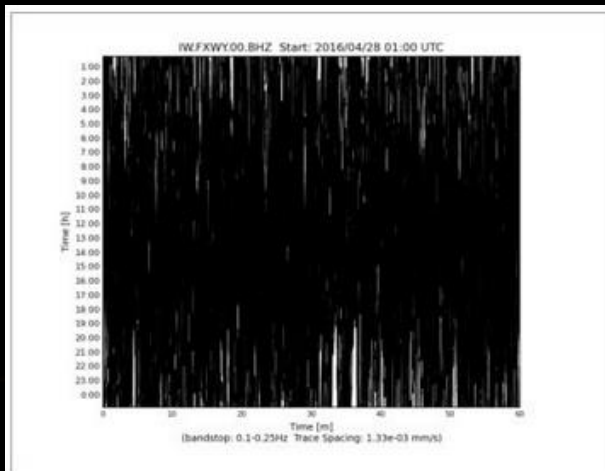

IW/LOHW Long Hollow, Wyoming, USA

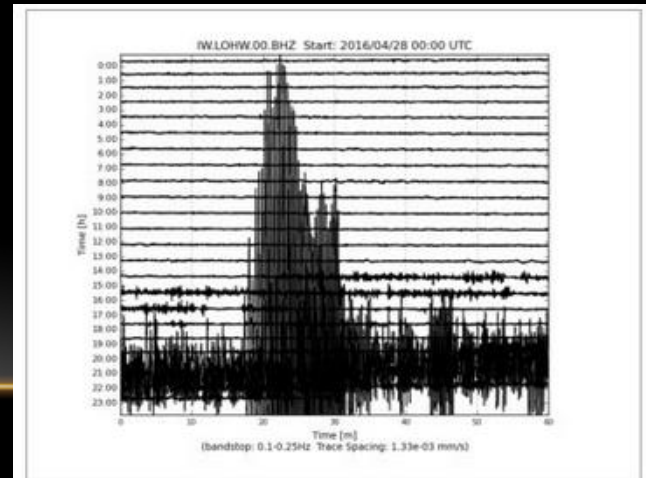

IW/MOOW Moose Ponds, Wyoming, USA

May 2016 –CHINA - The residents of the Chinese city of Kashgar were shocked to see their roads and houses disappear under the dust cloud within minutes of the storm's arrival. Many locals began suffering breathing difficulties from the eerie ash-filled streets. The wall of sand laid a thick blanket of dust on Kashgar and plunged the city in darkness. Residents were forced to endure the severe sandstorm for hours as the choking winds swept over the entire Xinjiang Uighur Autonomous Region, in northwest China.



GIFAK.NET

Isaiah 14:9

שְׂאוֹל מִתַּחַת רָגְזָה לְךָ לִקְרַאת בּוֹאֶךָ
עוֹרֵר לְךָ רִפְאִים כָּל-עֲתוּדֵי אֲרֶץ הַקִּים
מִכְּסֵּאוֹתָם כָּל מַלְכֵי גוֹיִם: | LEB OT RI

Sheol below is getting excited over you, to meet you when you come; it arouses the dead spirits for you, all of the leaders of the earth. It raises all of the kings of the nations from their thrones. | LEB

Sheol, the grave below, under is getting awakened, stirred up and roused up over and in direction to you, to meet and encounter you when you arrive; it arouses, alerts and stirs up dead spirits for you, all of the leaders of the earth. It raises up against all of the kings of the nations and people from their thrones.

Planet X to really cause mass extinction this month?

Published time: 9 Apr, 2016 07:54

[Get short URL](#)



© NASA

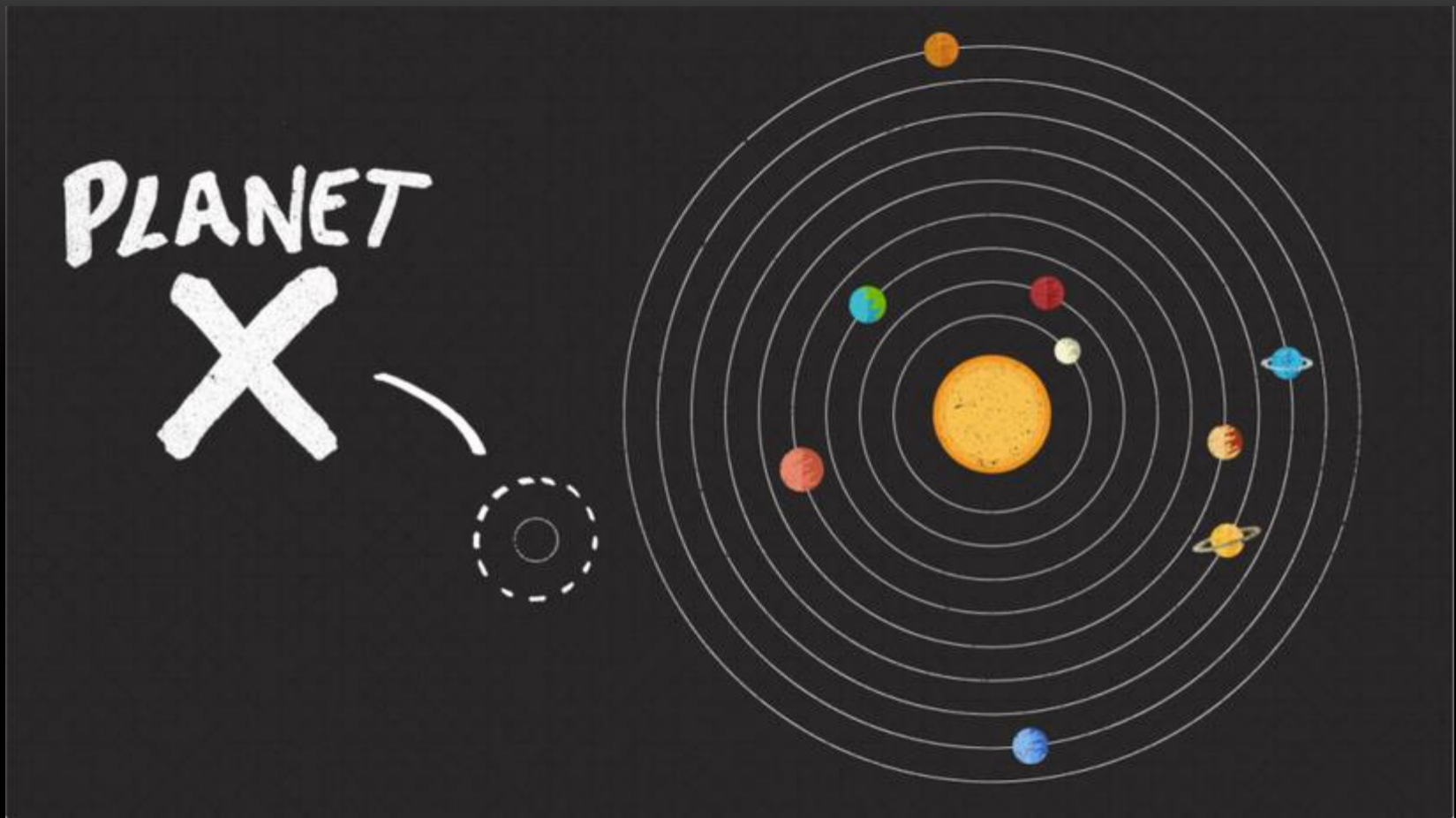

Planet X was the term first introduced by Percival Lowell, a US millionaire and space enthusiast, who died without finding the alleged planet. However, in 1930, Clyde William Tombaugh spotted a celestial object that he believed explained the perturbations in the orbit of Neptune, this was when he discovered Pluto.

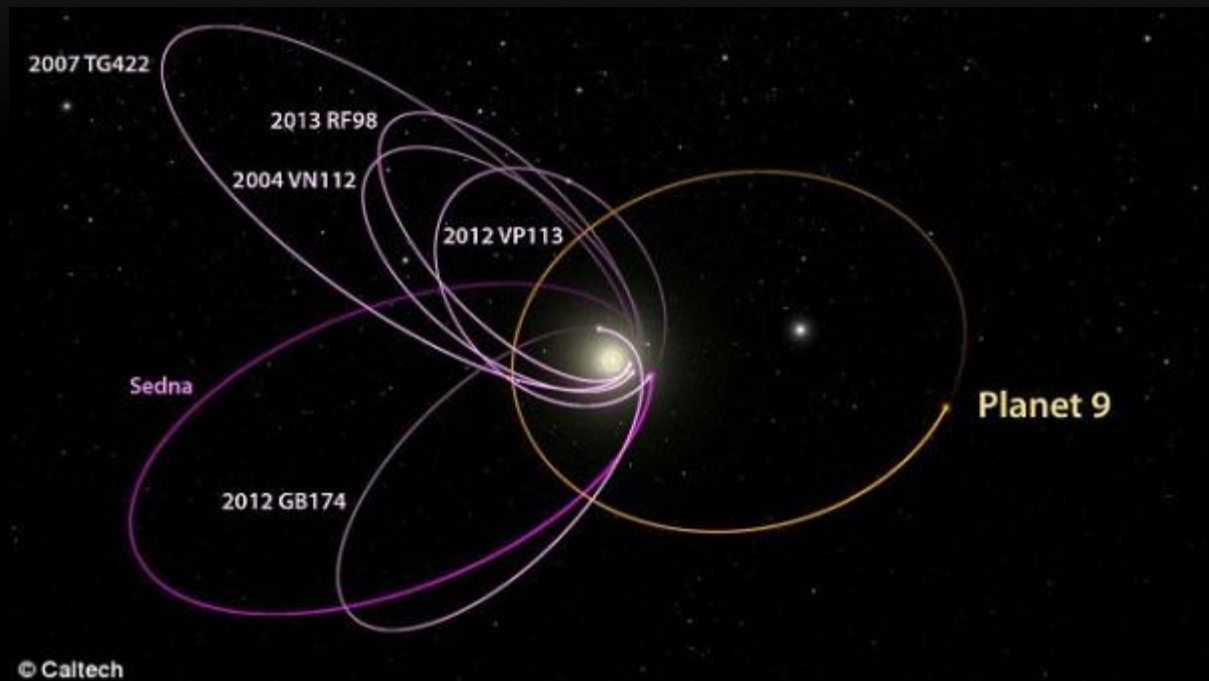

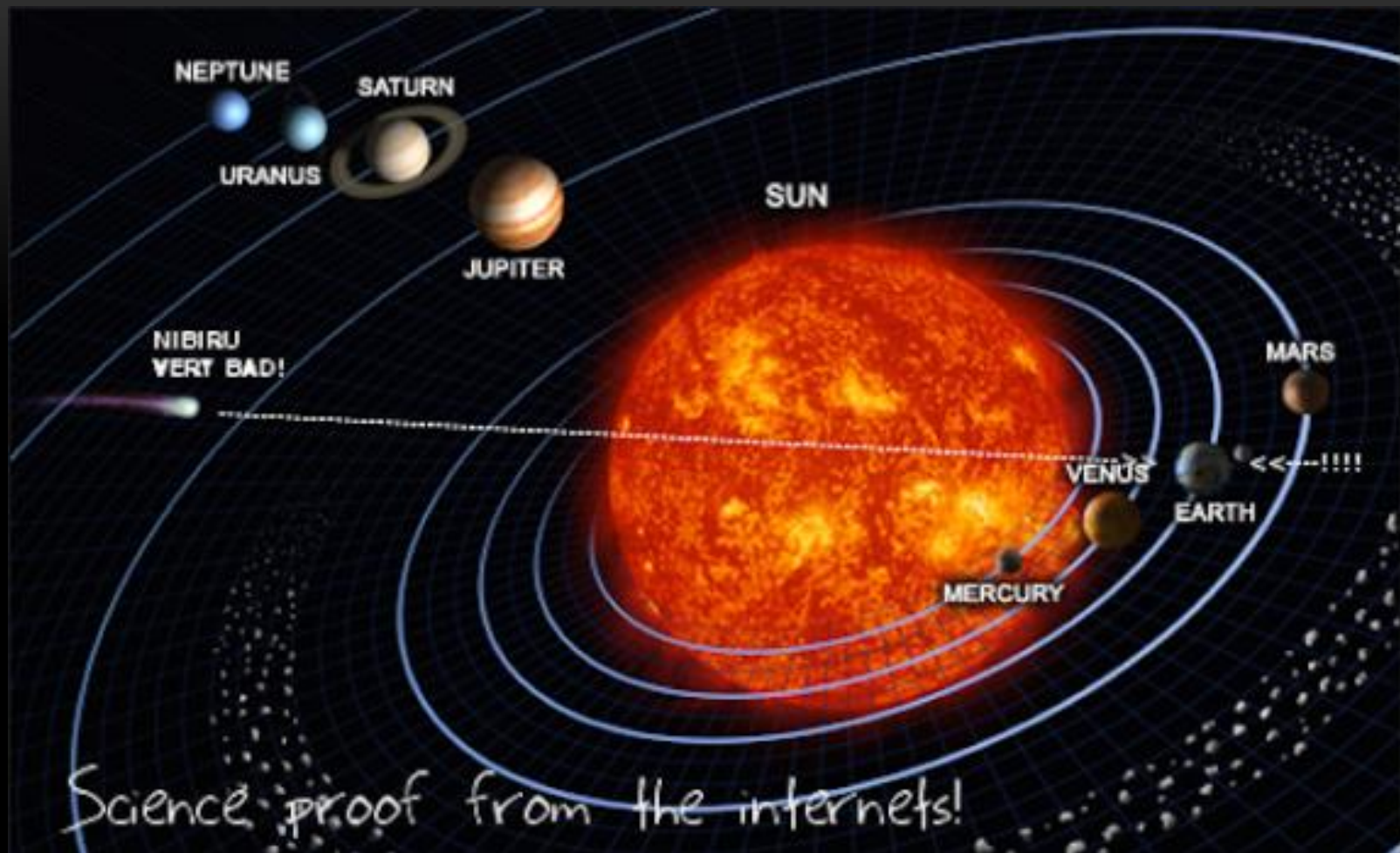



Planet X Is Being Quietly Shoehorned Into Our Daily Lives With Military Precision: Is The Alien Agenda Next?

<http://www.thebigwobble.org/2016/04/planet-x-is-being-quietly-shoehorned.html>

Is there really confirmation of a NINTH planet in our solar system?

It seems incredible to think but only a few months ago believers in Planet X were regarded as tin-foil hat conspiracy nuts who were regarded as nut jobs by NASA and the Military.

But now NASA are not only saying a ninth planet may exist but are saying it will be confirmed in the coming months.

However NASA must have known of the ninth planet's existence for a long long time, a group of Caltech scientists do not upstage the billion dollar space giants, or the military, come to that matter.

No NASA and the military have known about Planet X since it was first leaked into the conspiracy culture in the 1980's and is now being shoehorned into our daily lives with military precision.

In fact in the space of a few weeks the whole idea of a ninth planet is not just a fantasy but a probable reality

Scientists say they have even more evidence of the mysterious hidden world .

Astronomer reveals newly found KBO 'where Planet Nine says it should be' The mysterious gas giant is thought to be almost as big as Neptune, hard to miss then!

Signs of its existence were first found in January by Caltech scientists

So what is next on the agenda?

Aliens?

NASA finds planet 10 times the size of Jupiter floating in free space

Posted on April 23, 2016

<https://theextinctionprotocol.wordpress.com/2016/04/23/nasa-finds-planet-10-times-the-size-of-jupiter-floating-in-free-space/>

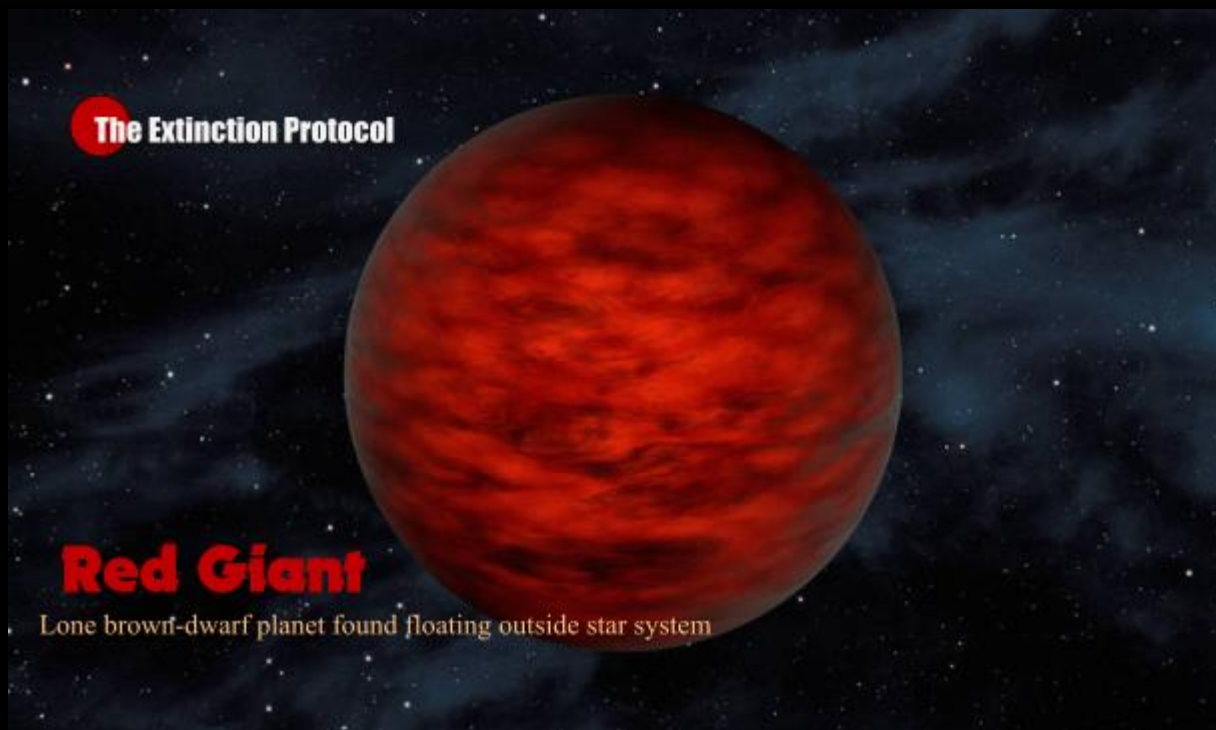

April 2016 – SPACE – NASA has discovered a new planet floating freely around the galaxy proving the theory that in the dark depths of space, lonely planets outnumber stars in the Milky Way. A recent study “provides new clues in this mystery of galactic proportions,” said NASA, after scientists found a free-floating, planetary-mass object within a young star family called the TW Hydrae association. The newly discovered planet, called WISEA 1147 for short, is thought to be up to ten times the size of Jupiter.

So NASA finds this and YET denies the existence of Planet X or Nibiru???

Is there REALLY a mysterious new planet out there? Nasa warns it is too early to confirm Planet X but pledges 'if it's there, we'll find it'

Gas giant is thought to be almost as big as Neptune

Orbits billions of miles beyond Neptune's path

Planet is distant enough to take 10,000 to 20,000 years to circle the sun

Team has booked time on Hawaii telescope that could confirm find

See more news from NASA on Planet X at www.dailymail.co.uk/nasa

By [Mark Prigg For Dailymail.com](http://www.dailymail.com)

Published: 16:46 EST, 21 January 2016 | Updated: 09:28 EST, 22 January 2016

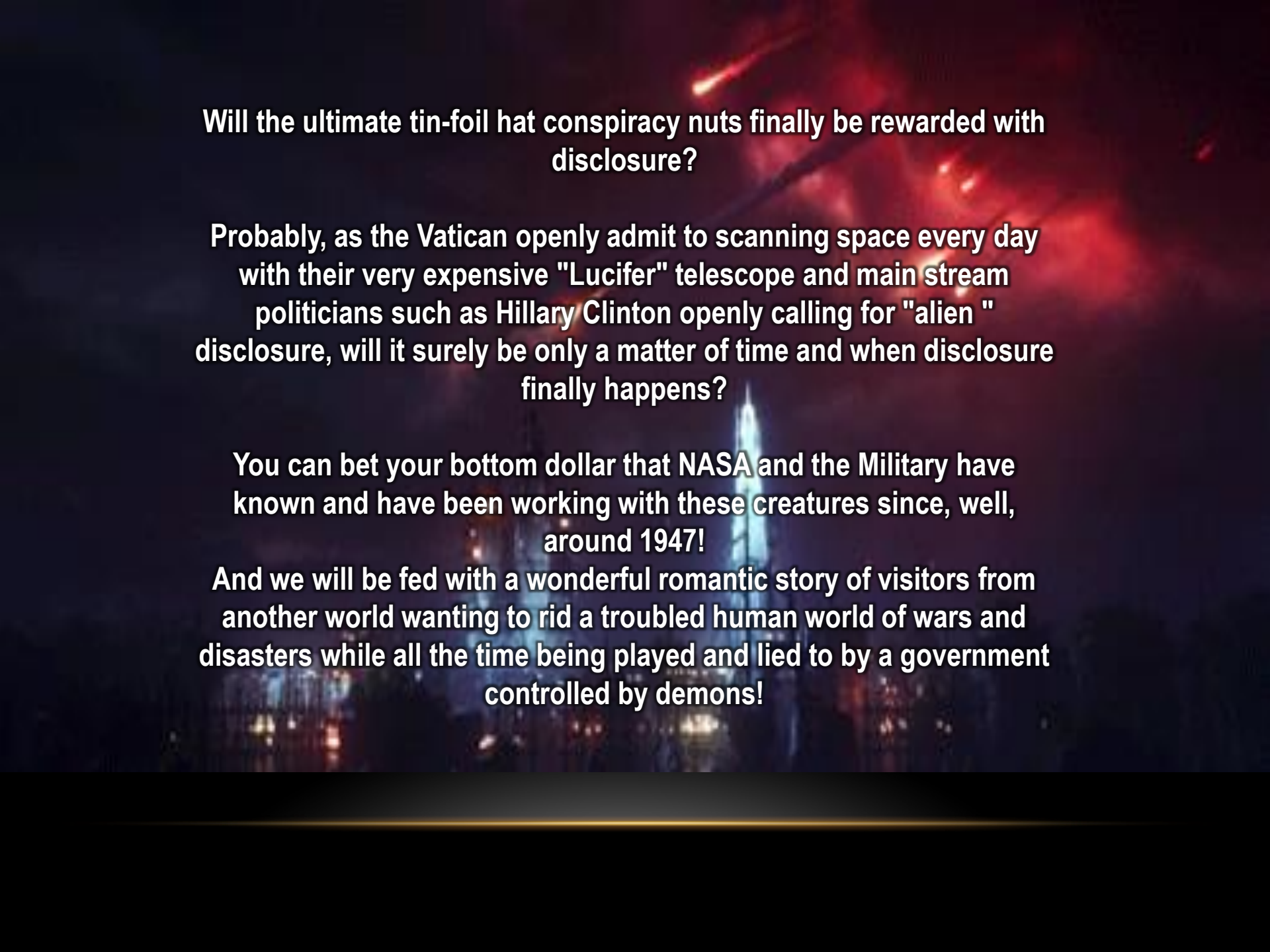

Will the ultimate tin-foil hat conspiracy nuts finally be rewarded with disclosure?

Probably, as the Vatican openly admit to scanning space every day with their very expensive "Lucifer" telescope and main stream politicians such as Hillary Clinton openly calling for "alien " disclosure, will it surely be only a matter of time and when disclosure finally happens?

You can bet your bottom dollar that NASA and the Military have known and have been working with these creatures since, well, around 1947!

And we will be fed with a wonderful romantic story of visitors from another world wanting to rid a troubled human world of wars and disasters while all the time being played and lied to by a government controlled by demons!



S'abonner

PHOTOS FROM AROUND THE WORLD OF WHAT LOOKS LIKE A SECOND SUN. THANK

▶ ⏪ 🔊 0:51 / 55:28 CC ⚙️ 📺 🖱️

Planet X Visible Now May 2016 Multiple Sources/Photos Nibiru, Wormwood & Binary Star System

DOC tv world

<https://www.youtube.com/watch?v=WuJkA48MoyE>



3a. 04 30 2016f.jpg



3b. 04 30 2016g.jpg



3c. 05 01 2016m.jpg



3d. 05 01 2016n.jpg

Anne-Marie Bissonnette , Quebec Canada

30 Avril 2016 , 19:45 hrs (pm)

reduce Brightness and ajust Contrast



S'abonner

7:03 / 55:28

CC Settings Full Screen



1. Two Suns.jpg



2. Planet X Moon.jpg



2a. 04 30 2016m.jpg

Parmelia (ESE) Australia
02.05.2016 - 05:47am

Edit Enael Pires



Sabonner



5:01 / 55:28

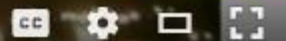



04_30_2016i.jpg



IMG_2813-1.JPG



4a. IMG_2343.PNG

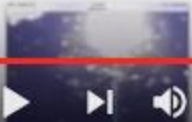

www 1 mobile LTE 7:24 PM altoplan.com

Refraction

Planet X and three planets

Subscriber

11:58 / 55:28

CC Settings Full Screen

Isaiah 28:15

כִּי אָמַרְתֶּם כְּרַתְנּוּ בְרִית אֶת־מָוֶת
וְעַם־שְׂאֵוֹל עָשִׂינוּ חֵזֶה שֵׁיט שׁוֹט שׁוֹטָף
כִּי־עֶבֶר יַעֲבֹר לֹא יְבֹאֲנוּ כִּי שִׁמְנוּ כֶזֶב
מַחֲסֵנוּ וּבִשְׂקָר נִסְתַּרְנוּ: | LEB OT RI

Because you have said, “We have made a covenant with death, and we have made an agreement with Sheol. *The overwhelming flood*, when it passes through, will not come to us, for we have made lies our refuge, and we have hidden ourselves in falsehood.” | LEB

Indeed you have said, “We have made a covenant and pledge with death, and we have made an agreement and contract with Sheol, the grave. Like the sudden spate of water overflowing like a flood, when it passes through, will not come for us, for we have made and caused lies and falsehoods our refuge, and we have hidden and concealed ourselves in falsehood and deception.”

Isaiah 28:18

וְכִפַּר בְּרִיתְכֶם אֶת-מָוֶת וְחֻזוֹתְכֶם
אֶת-שְׂאוֹל לֹא תִקּוּם שׁוֹט שׁוֹטָה כִּי יַעֲבֹר
וְהָיִיתֶם לוֹ לְמַרְמָס׃ | LEB OT RI | LEB

And your covenant with death will be annulled, and your agreement with Sheol will not stand; you will become a trampling place for *the overwhelming flood* when it passes through . | LEB

And your covenant and pledge with death will be purged and coated over with tar, and your agreement, contract with Sheol, the grave will not stand and be established; you will become a trampling place for the sudden spate of water overflowing like a flood, when it passes through.

PROJECT BLUE BEAM

<http://www.thewatcherfiles.com/bluebeam.html>



The infamous NASA Blue Beam Project has four different steps in order to implement the new age religion with the antichrist at its head. We must remember that the new age religion is the very foundation for the new world government, without which religion the dictatorship of the new world order is completely impossible. I'll repeat that: Without a universal belief in the new age religion, the success of the new world order will be impossible! That is why the Blue Beam Project is so important to them, but has been so well hidden until now.

The first step concerns the breakdown of all archeological knowledge. It deals with the setup with artificially created earthquakes at certain precise locations on the planet where, supposedly, new discoveries will finally explain to all people the error of all fundamental religious doctrines. The falsification of this information will be used to make all nations believe that their religious doctrines have been misunderstood for centuries and misinterpreted. Psychological preparations for that first step have already been implemented with the film, "2001: A Space Odyssey;" the StarTrek series, and "Star Wars;" all of which deal with invasions from space and the coming together of all nations to repel the invaders. The last films, "Jurassic Park," deals with the theories of evolution, and claim God's words are lies.

What is important to understand in the first step is that those earthquakes will hit at different parts of the world where scientific and archeological teachings have indicated that arcane mysteries have been buried. By those types of earthquakes, it will be possible for scientists to re-discover those arcane mysteries which will be used to discredit all fundamental religious doctrines. This is the first preparation for the plan for humanity because what they want to do is destroy the beliefs of all Christians and Muslims on the planet. To do that, they need some false "proof" from the far past that will prove to all nations that their religions have all been misinterpreted and misunderstood.

The second step involves a gigantic "space show" with three-dimensional optical holograms and sounds, laser projection of multiple holographic images to different parts of the world, each receiving a different image according to predominating regional national religious faith. This new "god's" voice will be speaking in all languages. In order to understand that, we must study various secret services' research done in the last 25 years.

The Soviet's have perfected an advanced computer, even exported them, and fed them with the minute physio-psychological particulars based on their studies of the anatomy and electro-mechanical composition of the human body, and the studies of the electrical, chemical and biological properties of the human brain. These computers were fed, as well, with the languages of all human cultures and their meanings. The dialects of all cultures have been fed into the computers from satellite transmissions. The Soviets began to feed the computers with objective programs like the ones of the new messiah. It also seems that the Soviets - the new world order people - have resorted to suicidal methods with the human society by allocating electronic wavelengths for every person and every society and culture to induce suicidal thoughts if the person doesn't comply with the dictates of the new world order.

Ghostly apparition of entire city appears over Chinese river... but is it just a mirage?

By [Daily Mail Reporter](#)

Updated: 11:05 EST, 26 June 2011



Mirage: An entire island with trees, tall buildings and mountains in the distance can be seen in the dusk light in the Chinese city where hours before it was only an expanse of water

Amazed residents recorded the footage with some even suggesting that it could have been a 'vortex' to a lost civilisation.

The pictures have baffled experts who visited the city to check that there were not actually any of the building already there.

It is believed that the sight may have been a mirage - a form of illusion that is common in humid weather.

The phenomenon is caused when moisture in the air becomes warmer than the temperature of water below.

As the rays of sunlight cross from the colder air into the warmer air it is 'bent' or refracted - creating a reflection in the air.

The patterns in the mirage are typically blurred and shimmering with a resemblance to human structures. They are similar to a reflection seen in water.



Brother Karaviro/YouTube

A rare mirage has made a floating city appear over China

No, it's not a NASA conspiracy.

FIONA MACDONALD 19 OCT 2015



13.9k



A few weeks ago, residents in the city of Foshan in China's Guangdong province were alarmed when a floating city suddenly [appeared in the clouds](#) above them.

There are two different aspects of step two. The first is the "space show." Where does the space show come from? The space show, the holographic images will be used in a simulation of the ending during which all nations will be shown scenes which will be the fulfillment of that which they desire to verify the prophecies and adversary events. These will be projected from satellites onto the sodium layer about 60 miles above the earth. We see tests every once in a while, but they are called UFOs and "flying saucers." The result of these deliberately staged events will be to show the world the new "christ," the new messiah, Matreya, for the immediate implementation of the new world religion. Enough truth will be foisted upon an unsuspecting world to hook them into the lie. "Even the most learned will be deceived." The project has perfected the ability for some device to lift up an enormous number of people, as in a rapture, and whisk the entire group into a never-never land. We see tests of this device in the abduction of humans by those mysterious little alien greys. who snatch people out of their beds and through windows into waiting "mother ships."

The calculated resistance to the universal religion and the new messiah and the ensuing holy wars will result in the loss of human life on a scale never imagine before in all of human history. **The Blue Beam Project will pretend to be the universal fulfillment of the prophecies of old, as major an event as that which occurred 2,000 years ago. In principle, it will make use of the skies as a movie screen (on the sodium layer at about 60 miles) as space-based laser-generating satellites project simultaneous images to the four corners of the planet in every language and dialect according to the region. It deals with the religious aspect of the new world order and is deception and seduction on a massive scale. Computers will coordinate the satellites and software already in place will run the sky show.**

Pope Francis Makes Proclamation For a One World Religion



The Church of Perpetual Life Wants to End Deathism

WRITTEN BY ZOLTAN ISTVAN

April 11, 2016 // 12:00 PM EST

Once seen as fringe, but now increasingly seen as potentially visionary, transhumanists are challenging the very nature of what it means to be a human being.

Motherboard recently featured a part of the transhumanism movement in an exciting and informative short documentary called *Forever Young*. The show focuses on the eclectic [Church of Perpetual Life](#)—a nonprofit transhumanist organization in south Florida aiming to combine spirituality, community, and hard science research. I recently spoke at the Church of Perpetual Life while on tour with my [Immortality Bus](#). The church is a unique place, to say the least.

Forever Young explores the transhumanist and spiritual beliefs of some of the church parishioners, including businessman Bill Faloon, who co-founded the church in 2013. Faloon and the parishioners—nearly all who doubt the existence of an afterlife—are people bent on using the latest anti-aging science to live indefinitely.

Gnostic chiliastic evolution: Satan's alternative plan of salvation

...so far as human wisdom and resources are concerned, the salvation of sinners is as impossible as raising the dead. Every conceivable method of expiation and purification has been tried without success."
Charles Hodge

Chiliastic-evolutionary systems are modern forms of ancient and very "elitist" pre-Christian and Christian-era Gnosticism which assigns the Holy Triune God to hell and instead worships Lucifer. Furthermore, it teaches that salvation is attained through the 'elitist' knowledge of Gnostic teachers such as gurus, god-men, certain scientists and Oprah Winfrey, a contemporary spiritual guide possessed of the knowledge of the Gnostic cosmogony.

"...it is but natural...to view Satan, the Serpent of Genesis, as the real creator and benefactor, the Father of Spiritual mankind..." (Theosophy University Press, 1888, p. 243, 513)

That quest of “man” to rule “death” given as a false promise by the adversary – eternal life, if you will only give up your body. Put in new parts, and if they wear out, just go to the local store and get replacements. That’s the new and improved view of immortality. But there is a “caveat”, the transhumanist ONLY talk about keeping the body alive forever – that doesn’t include your SOUL, your NEPHESH!!

Is living here on this earth SO extraordinary that you want to stay here forever??
Man destroys and those “elites” who live to rule and enslave and gather as much wealth as possible do that for whose benefit? Where is the promise of riches to all these followers, it only promises living forever. What happens if that one finger pushes that one button that destroys the world, then what is left in your trans-humanistic world?

Psalm 116:7

שׁוּבִי נַפְשִׁי לְמִנוּחַיִכִי כִּי־יְהוָה גָּמַל

Return, O my soul, to your repose, for Yahweh has dealt bountifully with you. | LEB

עָלִיכִי: | LEB OT RI

Psalm 116:8

כִּי חִלַצְתָּ נַפְשִׁי מִמָּוֶת אֶת־עֵינַי מִן־דִמְעָה

For you have rescued *me* from death, my eyes from tears, my feet from stumbling. |

אֶת־רַגְלִי מִדְּחִי: | LEB OT RI LEB

Return and come back, O my soul, heart and life, to your repose, resting place, home, for Yahuah has dealt and given recompense and bounty with you. Indeed you have rescued and delivered me from death and pestilence, my eyes from tears and weeping, my feet from missteps and stumbling.

Large Hadron Collider Created A Portal To Another Dimension?

Large Hadron Collider Created A Portal To Another Dimension?

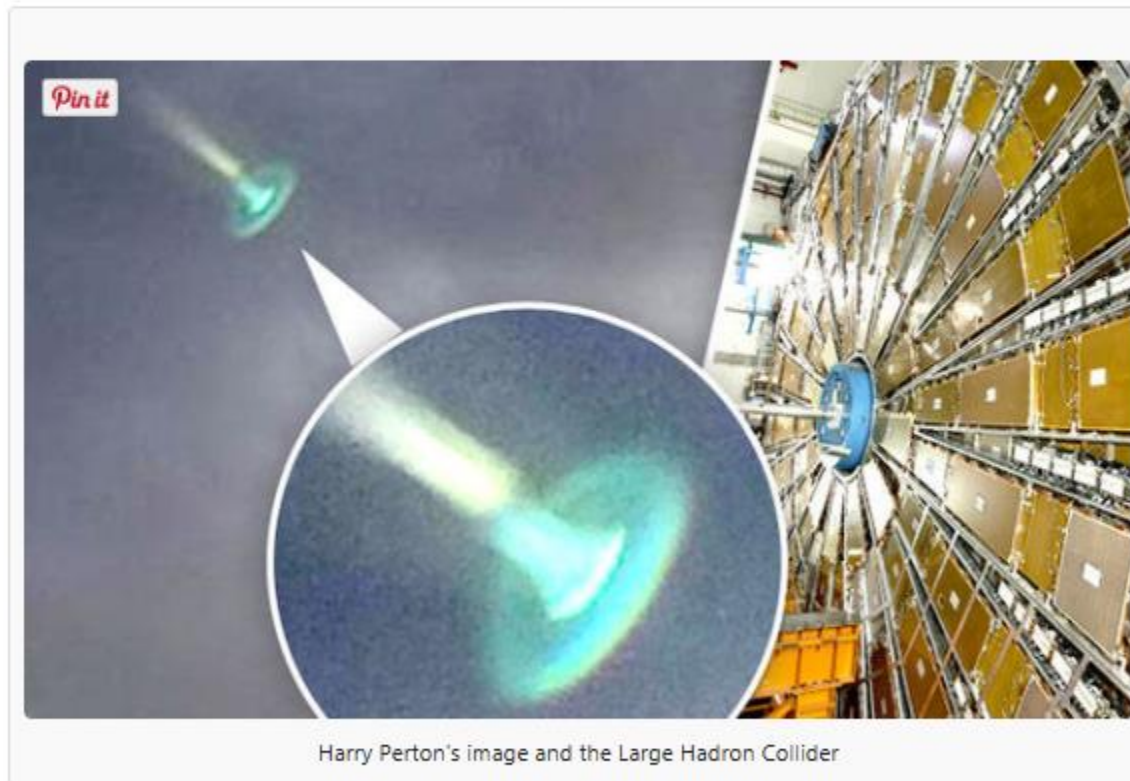

As U.I.P stated recently, the bizarre UFO sighting in the sky above the Netherlands, looks VERY much like a Portal than anything else! Could it be that the Large Hadron Collider (LHC) has opened up a Portal in the sky to Another Dimension?

The Gentleman who caught this incredible sighting was Dutch snapper Harry Perton, who was photographing stormy evening skies at the time over Groningen in his homeland, when all of a sudden there was a HUGE flash as he fired the shutter! Some people believe that this very well could be a wormhole to another Dimension.



Harry Perton's astonishing original picture

I am sure that a lot of you reading this will already know this, but Wormholes are a VERY mysterious scientific theory that there are openings in space-time to another part of the universe or even another dimension. It is very important to remember when discussing Portals/wormholes, that they are actually very real and even our silent friends in NASA not so long confirmed their existence (click [HERE for confirmation](#)).

A **wormhole** is a theoretical passage through space-time that could create shortcuts for long journeys across the universe. **Wormholes** are predicted by the theory of general relativity. But be wary: **wormholes** bring with them the dangers of sudden collapse, high radiation and dangerous contact with exotic matter. Apr 13, 2015



What is a Wormhole? - Space.com ✓

www.space.com/20881-wormholes.html Space.com ▼

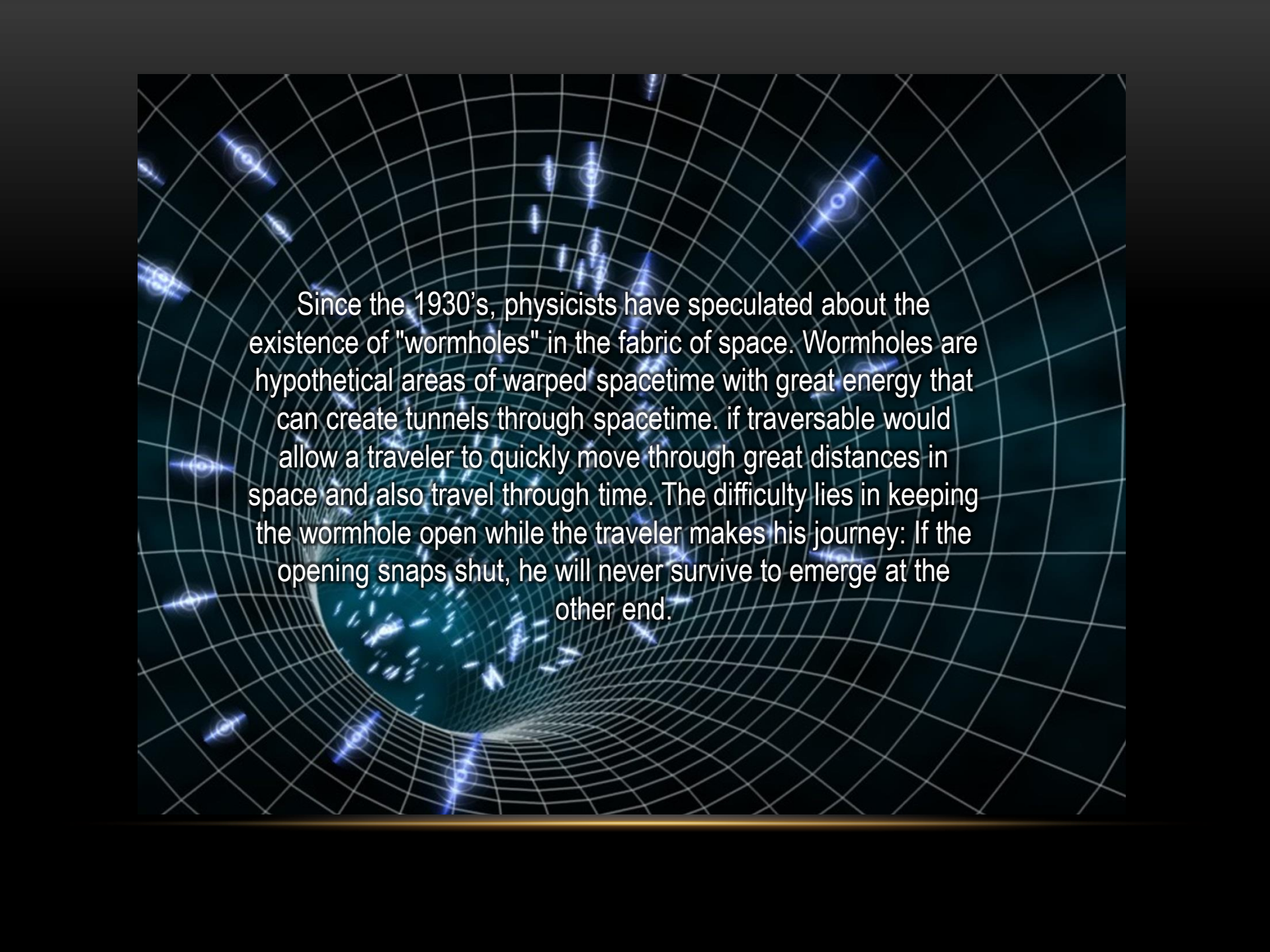

Since the 1930's, physicists have speculated about the existence of "wormholes" in the fabric of space. Wormholes are hypothetical areas of warped spacetime with great energy that can create tunnels through spacetime. If traversable would allow a traveler to quickly move through great distances in space and also travel through time. The difficulty lies in keeping the wormhole open while the traveler makes his journey: If the opening snaps shut, he will never survive to emerge at the other end.

Declassified Documents Reveal The Nazi Bell Was A Secret Worm Hole Time Machine

By *conspiracyclub* - May 15, 2015

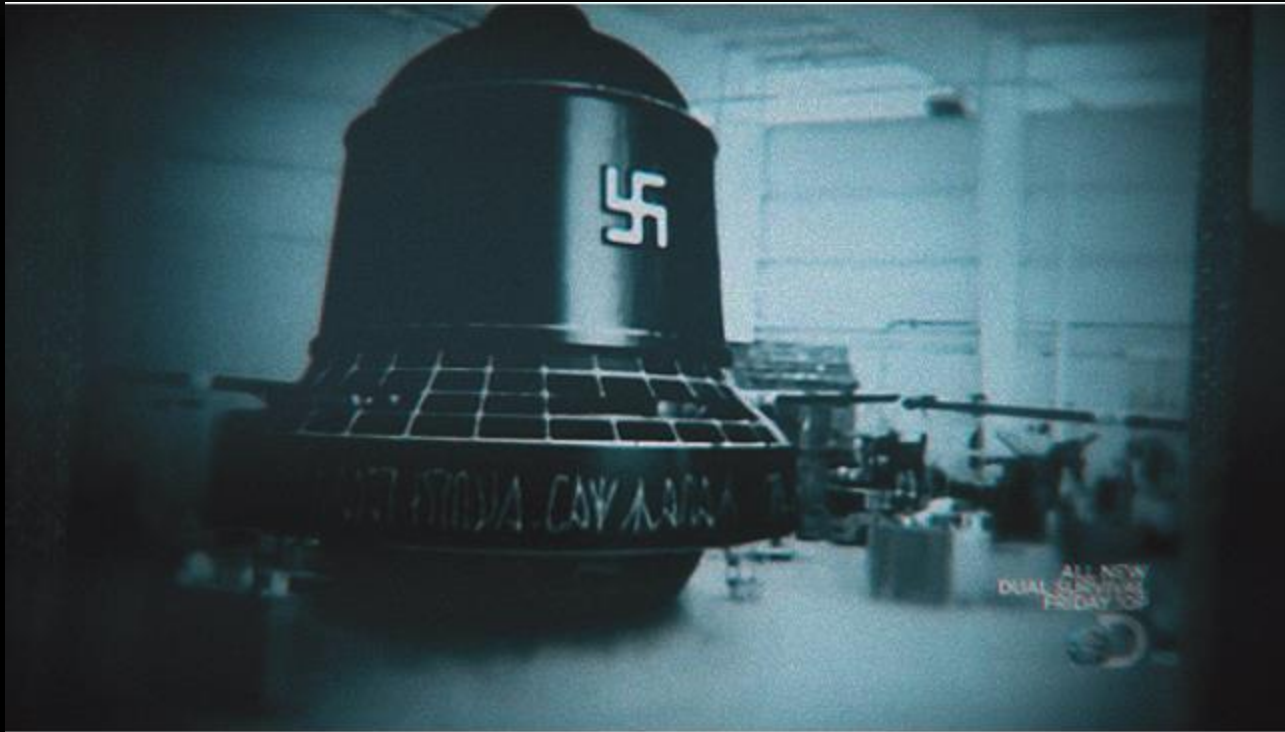

Leaked information and de-classified documents have given us the direction in understanding of what this “bell” was all about. It was when in Igor Witkowski’s book called “The Truth About The Wonder Weapon”, this weapon was first introduced to us. He claims that he has been shown classified Polish Government documents by an anonymous Polish intelligence official. In these documents were the most important Nazi research projects, and among them was Die Glocke.



Did the Nazi's create a wormhole with the super powerful Nazi bell and plummet somewhere in time? Where is the device now?



NAZI BELL



KECKSBURG ACORN



NOTE: STRANGE INSCRIPTIONS WERE FOUND ON BOTH THE NAZI BELL AND KECKSBURG ACORN

Did the Nazi's create a wormhole with the super powerful Nazi bell and plummet somewhere in time? Where is the device now? So many questions rise from such an intriguing experiment making it the most mysterious objects known to man, and if it does still exist, in which hands is it?

Five decades later, the Kecksburg UFO is identified (probably)
December 6, 2015 12:00 AM



Pam Panchak/Post-Gazette

John Ventre, state director of the Mutual UFO Network, stands in front of a replica of an unidentified flying object that came down Dec. 9, 1965, in Kecksburg, Pa.

Fifty years after the famous Kecksburg UFO streaked across the December sky and landed in a wooded hollow, two Westmoreland County researchers have put forth a theory that they say explains it.

The unidentified flying object that came down Dec. 9, 1965, they say, was a General Electric Mark 2 Re-entry Vehicle that had been launched by the Air Force as a spy satellite, but fell out of orbit.

Authorities at the time, however, said it was a meteorite. That official claim has been challenged but never changed.

Researchers consider the Kecksburg UFO one of the great unsolved mysteries, and people in the tiny town of Kecksburg still talk about it. Witnesses who saw it — before members of the military swooped in and took it away — say it was not a meteor but a craft of some kind.



Artist Rendition of Acorn Shaped UFO that crashed in Kecksburg Pa. 12/9/65



I'M A PHYSICIST AT CERN: 'WE'VE DONE SOMETHING WE SHOULDN'T HAVE DONE'

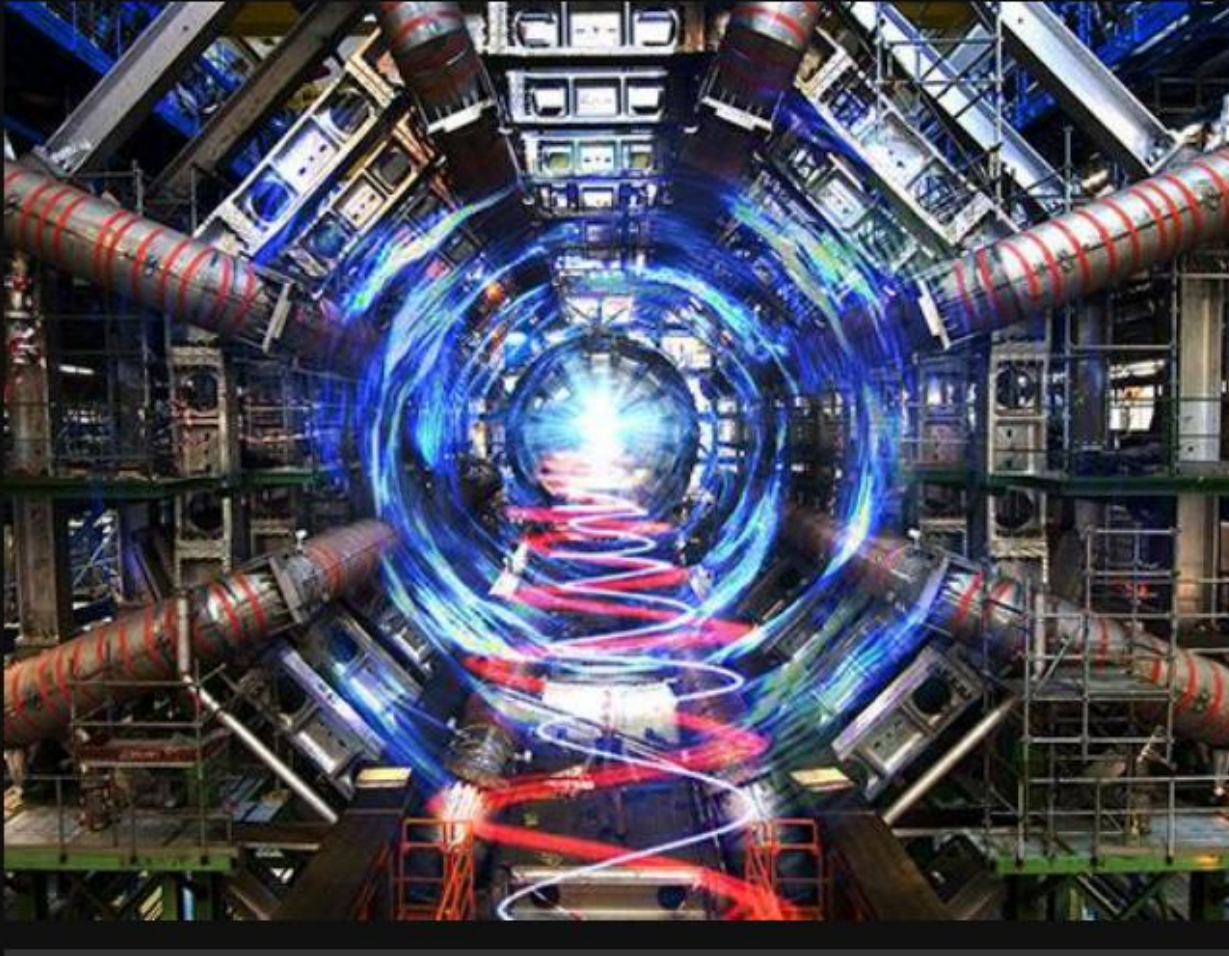

My name is Dr. Edward Mantill and I was (technically still am) a physicist at CERN, located in

Geneva, Switzerland. I specialize in particle and subatomic research, focusing on quark interactions. In other words, I study very very small particles and how they interact with one another at very high speeds. Until Thursday, Jan.

15, 2014 I was a normal scientist living and working on the CERN campus. Most of the scientists who are involved in the branch of research that I am live on campus at the facility in Geneva and venture out only for social activities and the occasional visit home.

http://www.disclose.tv/news/im_a_physicist_at_cern_weve_done_something_we_shouldnt_have_done/130410?utm_source=facebook&utm_campaign=4702&utm_content=turbo&utm_medium=paid

CERN Scientist Disappears - July 24, 2015 - Read by ...



<https://www.youtube.com/watch?v=aNGkv35W2SY> ▾

Jul 24, 2015 - Uploaded by Be Free

My name is Dr. Edward Mantill and I was (technically still am) a physicist at CERN, located in Geneva ...

During the 1980s billions of dollars of research was funnelled into the idea that if we used enough energy, if we used enough force, concentrated into a small area (the size of a pin prick) we could theoretically tare our page and get a glimpse of the page next to ours. We could open a door from their universe to ours. When the Family (the code name for the group of scientists that functioned as the head of each of their departments at CERN) were shown the initial presentation in March of 1981, many of them expressed grave concern about the ramifications of opening such a doorway. But in the beautiful name of science, the Family decided to share these ideas with the governments who constantly funded their research. At a meeting held in Luxembourg, the heads of state of the newly forming European Union, along with the United States and China were shown plans for the construction of a colossal machine that would enable the opening of a doorway that could be closed at our discretion. The door would be opened, and the energy levels would be measure to prove that CERN had accomplished its task, and the door would be closed. Open. Shut. Simple as that.

The government leaders threw endless funding at the Family and the rest of CERN in the hopes of understanding what kind of power lay in another universe. Think of the possible endless source of Energy, faster than light travel, weaponry that could obliterate enemies using laser. The possibilities for power were truly staggering. So, the public was fed one narrative (“understanding the universe”) and the Family and governments knew the truth.

Most of the scientists at CERN were kept completely in the dark, after all the collider would perform it's function as normal and collide particles for eager funding hunters to capitalize on. But the far more nefarious purpose would only be tested in the presence of the Family and a few select scientists. I am the member of the Family for my division.

Obviously the original Family have all retired or died out, but there is a new, younger, more eager to prove themselves group now at the helm, and the consequences of this were and are dire. So, with that established, allow me to explain what happened last Thursday. It was an ordinary day with the LHC scheduled to commit two collisions, one at 9am and the other at 630PM. Both went off magnificently and the experiments were deemed a success. We witnessed two full collisions and the general group of researchers were very happy with their work.

At the head of the table was Father, a young, rather ambitious physicist named Sandra O'Reilly, designated, "Father," since she was in charge of giving orders to the Family with respect to our clandestine experiments. The mood in the living Room was never tense, but rather one of controlled excitement. The Family had been attempting these tests once every 6 months for the past 10 years without much success. We had gone through several, "Fathers," from the great Dr. Bertramberg to the lesser known and constantly drunk Dr. Yao, Each had failed to achieve what the original Family had planned. Billions were spent, but no door had yet been opened. "Tonight, we try 40 Tera Electron Volts," Father announced.

We all continued to look at one another, the concern growing graver and graver.” “Achieving 38 TeV” another announcement. But nothing, no explosion, no catastrophic failure, nothing. In theory 40 was possible, but never advisable, however at 38, no specific structural damage signs were noted, nothing. “40 TeV achieved.” We looked at one another in astonishment. We had achieved what we thought was impossible: 40 TeV of energy was pushing the particles through the collider and we were sustaining it.” As the two particle clouds whizzed past each other, our first indication that something different was going to happen started to occur. There was a sudden spike in the temperature of the room. we could feel that it had gotten warmer, and the first reaction was one of panic. “SHUT THE MACHINE DOWN!” Came the first exclamation from a Family member. “The Machine is heating up, explosion could be imminent!” She continued. “WAIT!” Exclaimed father, her eyes glowing with the reflection of the computer screen in front of her, “Look at the core temperature read out, they haven’t changed, they’re perfectly normal!”

We each looked at the closest computer screen we could find, all of them showing that everything was going well, except for the fact that the thermostat in the room now read 35 degrees celsius, when we started out at a pleasant 20. Could this be it? "COMMENCE THE COLLISION SEQUENCE." Father barked the order into the microphone near her control console. "Collision in 4...3...2..." The methodical voice announced over the intercom. "1" – An ethereal blinding light consumed the room, I had never experienced anything like this before. The temperature dropped back down to 20 degrees, and the light was overpowering us. We couldn't see our own hands in front of our faces. Suddenly there was a blood curdling scream, like someone being horribly beaten, followed by complete and total silence and then darkness. "Is everyone ok!" Celine was shouting from her side of the room. "I'm fine!" I called back, "Sound off!" "Mantill, code: Fam-0113" "D'Accord, Code: Fam-0115" "Chung, Code: Fam – 0114" The Family members present started to scream out their names and code designation as our eyes adjusted to the total darkness that had encompassed the room.

With the sound of a bang the emergency red lighting bathed the room in a lambent glow. We could make out shadows, but no distinguishing features. By this time, approximately 2 minutes after our encounter with the white light, we still had not heard Father sound off. “Where is Father!” Dr. Chung called out. We all turned to the seat that Father sat in, and could see a lump on the chair, but no sign of her. I entered the panel code to open the emergency exit and made my way through the escape corridor to the lighting box at the end of the hall. I turned the breaker and the normal lighting filled the control room again. Panic struck for Father’s well being I turned and ran back into the control room. All of my fellow scientists were in complete and total awe. Nothing in the room was out of place, and the temperature had returned to normal, however sitting in Father’s chair was a pile of her effects. Celine ran up to the chair Father once filled and looked down with a gasp. “She’s gone! All of her things are here, her jewellery, her clothes, her tamp..., everything!” Where Father sat now rested her physical possessions. She had vanished into thin air (via worldtruth.tv).

Head Of The Army Gives Strange Speech - "Prepare For little green men and hybrid armies"



https://www.youtube.com/watch?v=zqY9-xxC_NY

Army Chief of Staff Gen. Mark Milley was the keynote speaker at Norwich University during its Reserve Officer Training Corps Centennial Symposium, Northfield, Vermont, on April 21, 2016. During his speech he talked about "little green men and hybrid armies".

SGT Report: This is a big one. This is General Mark Milley. He's the U.S. Army Chief of Staff and he was giving the keynote address to the ROTC Centennial Symposium on April 22nd, 2016.

“You’re going to be leading the soldiers, sailors, airmen and marines in that world. You’ll be dealing with terrorists, you’ll be dealing with hybrid armies, you’ll be dealing with little green men, you’ll be dealing with tribes, you’ll be dealing with national leaders and local leaders.”

Hybrid armies...that will be those super soldiers who have decided to take chips, change their DNA, becoming part human, part machine. A CHIMERA, like in the days of Noah!! Along with that will be robots, cyborgs and anything else these mad scientists and elites can come up with!!

The incredible mystery of the 'alien spacecraft' that lies at the bottom of the Baltic Sea

APRIL 26, 2016 10:10AM

Advertisement

Mysterious Object Found on Baltic Seafloor



<https://www.youtube.com/watch?v=I2HT21s5NA0>

WHEN the mystery object at the bottom of the Baltic Sea was first spotted in 2011, it baffled experts and excited alien hunters. They still don't know what it is.

Dubbed the "Baltic Sea Anomaly", the structure looks like the Millennium Falcon from *Star Wars*.

It was discovered five years ago by Swedish treasure hunters, Ocean X team, led by Peter Lindberg, its captain, and his co-researcher Dennis Asberg, *The Sun* reports.

They used a side-scan sonar and found something strange 91 metres below the surface of the water. It was reported that the divers exploring the anomaly said their equipment stopped working as they approached it.

"Anything electric out there, and the satellite phone as well, stopped working when we were above the object," professional diver Stefan Hogerborn, part of the Ocean X team, said.

"And then when we got away about 200 metres, it turned on again, and when we got back over the object it didn't work."

The 61-metre-wide and eight-metre-tall circular object hit the headlines, with many speculating the anomaly could be a giant mushroom, a sunken Russian ship or an alien spaceship.

A sample recovered by divers was given to geologist Steve Weiner who ruled out the possibility of it being a natural geological formation.

After examining fragments, he claimed that the materials were "metals which nature could not reproduce itself".

Some experts think it's a Nazi anti-submarine device or a battleship gun turret.

Other observers believe it is a UFO called the "Roswell of the Ocean", but there is still no evidence to suggest that the UFO-like object is an alien ship.

**THERE ARE NO
ALIENS FROM
OTHER
PLANETS...**

**BUT THERE ARE
DEMONS FROM
OTHER REALMS..**

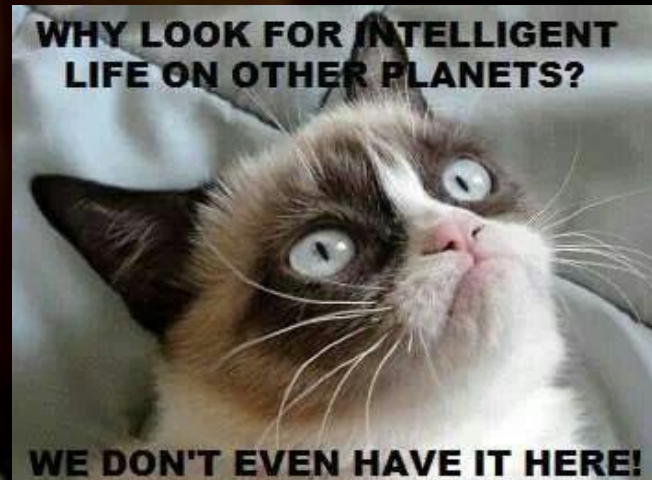

Whistleblower: Massive Extraterrestrial Crafts Hiding Behind Moon

6/9/2016

<http://helenastales.weebly.com/blogue/whistleblower-massive-extraterrestrial-crafts-hiding-behind-moon>



Dr. Eric Norton, an outside consultant for the NSA and NASA for the past 12 years, was hired to track various object in space including meteors, comets, etc.. but recently has been following a number of unidentified aircrafts that were heading towards Earth.

On January 22, 2012, Dr. Norton was called to the MacDonald Observatory in Texas and saw massive, three dimensional black structures in space, in straight line formation advancing in the direction of planet Earth.



Upon all of the commotion around the government shutdown as well as the shutdown of numerous space monitoring programs, Dr. Norton finally made a call to a close friend who he worked with confidentially who told Norton that **“the objects reappeared and had repositioned themselves behind the moon”** in a circular type of alignment, which allowed them to dock to the backside of the moon in order to remain invisible to skywatchers.

Norton added that the blackout of all space monitoring programs was essential in **“keeping the lid on what had happened.”**

“We don’t know what they are, what they are doing or what they’re going to do. We do know that there have already been fluctuations in Earth’s gravity field and the gravity field which links the moon to the Earth.”

Now we have the rebuttal to this – that it’s a fake/hoax using photo shop – but then again, the way the world has become, it’s become difficult to know what is RIGHT – as Scripture says, even the ELECT will be deceived....all things that are being done now are used to “frighten” us – so if you are aware of how they play the game, then you know what they will do, as the adversary is a ONE-TRICK pony, using the same thing over and over again.

Another Phony Spaceship Surfaces On The Farside Of The Moon

21 January 2014

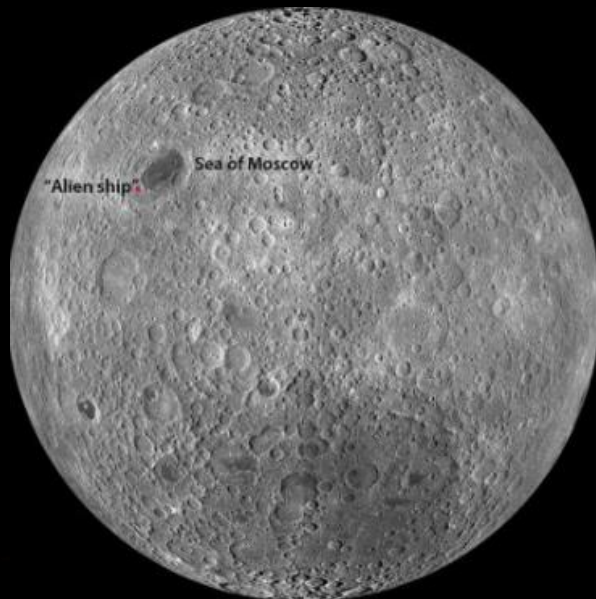

This full view of the moon's farside shows the location of the "alien ship" near the Sea of Moscow (Mare Moscoviense). Credit:

NASA

I was made aware of a new hoax by a faithful reader of this blog. Apparently NASA and the government have been hiding the fact that astronomers have been watching a fleet of black L-shaped craft through their telescopes the past two years. Last January they “disappeared” off radar near the orbit of Mars and then suddenly reappeared briefly near the moon before finding a hiding spot inside a small crater on the lunar farside

<http://astrobob.areavoices.com/2014/01/21/another-phony-spaceship-surfaces-on-the-farside-of-the-moon/>

The report, along with an interview with one “Dr. Eric Norton” (not his real name), appeared on the hoax-happy Turner Radio Network website on Jan. 20 under the headline “**Visually Confirmed: Enormous Craft Detected on Moon**”. It’s also seen in this **youtube video** and described as an alien base related to a similar triangle-shaped feature in Antarctica. Those aliens sure know how to find good hiding places!

So you have both sides – HOAX or REAL??? Who knows at this time, but it’s interesting that there are MANY things that once were supposedly HOAXES that turn out to be true, but those always have an AGENDA, and nothing ever good comes out of that!!!

TRANS-HUMANISM

transhumanism as “the radical field of science that aims to turn humans into, for lack of a better word, gods”



Genesis 6:4

הַנְּפִלִים הָיוּ בָאָרֶץ בַּיָּמִים הָהֵם וְגַם

אַחֲרֵי־כֵן אֲשֶׁר יָבֹאוּ בְנֵי הָאֱלֹהִים

אֶל־בָּנוֹת הָאָדָם וַיִּלְדּוּ לָהֶם הַמָּה

הַגִּבּוֹרִים אֲשֶׁר מְעוֹלָם אֲנָשֵׁי הַשָּׁם: | LEB

OT RI

The Nephilim were upon the earth in those days, and also afterward, when the sons of God went into the daughters of humankind, and they bore children to them. These were the mighty warriors that were from ancient times, *men of renown*. | LEB

The Nephilim, a renown race of giants came to pass upon the earth in those days, and an also afterwards or some time later, when the sons of Yahuah pursued, entered and cohabited with the daughters of humankind, and they begat and brought forth children to them. These mighty warriors that came out of ancient and everlasting times, servants of the Name, Yahuah.

Genesis 6:5

וַיֵּרָא יְהוָה כִּי רַבָּה רָעַת הָאָדָם בָּאָרֶץ
וְכָל-יִצְרָל מַחְשַׁבַת לְבָבוֹ רָע כָּל-הַיּוֹם׃ |
LEB OT RI

And Yahweh saw that the evil of humankind
was great upon the earth, and every
inclination of the thoughts of his heart was
always only evil. | LEB

Then Yahuah saw, perceived and understood that the evil, wickedness and perverseness of humankind was great, numerous and abundant upon and among the earth, and every thought, motivation and impulse of the thoughts, intentions and plans of his heart was always and in total only evil, wicked and perverse.

Genesis 6:6

וַיִּנְחַם יְהוָה כִּי־עָשָׂה אֶת־הָאָדָם בְּאָרֶץ
LEB OT RI | וַיִּתְעַצֵּב אֶל־לִבּוֹ: | LEB

And Yahweh regretted that he had made
humankind on the earth, and he was grieved
in his heart. | LEB

And Yahuah changed His mind and regretted the He had made and caused to appear humankind on the earth, and He was grieved, distressed and troubled in His heart and conscience.

Jude 6

ἀγγέλους τε τοὺς μὴ τηρήσαντας τὴν
ἑαυτῶν ἀρχὴν ἀλλὰ ἀπολιπόντας τὸ ἴδιον
οἰκητήριον εἰς κρίσιν μεγάλης ἡμέρας
δεσμοῖς αἰδίοις ὑπὸ ζόφον τετήρηκεν· | LEB
NT RI

And the angels who did not keep to their
own domain but deserted their proper
dwelling place, he has kept in eternal bonds
under deep gloom for the judgment of the
great day, | LEB

The supernatural messengers Yahuah created who did not guard, preserve and keep to their own origin, beginning, authority and domain but deserted , abandoned and left behind their proper and unique dwelling place and habitation. He has kept in eternal, everlasting and shameful bonds and chains of imprisonment under deep gloom and darkness for the judgement and punishment of the great and important day.

Enoch 10:4-6 And again Yahuah spoke to Rafa'al: "Bind Azazel hand and foot, and put him in the darkness; make an opening in the desert, which is in Dudael, and put him there. And lay upon him rough and pointed rocks, and cover him with darkness that he may remain there forever, and cover his face that he may not see the light! And on the great day of judgement and punishment he will be cast into the fire.

Enoch 10:7- 10 And heal the earth which the messengers have defiled, and announce the healing of the earth that I will heal it, and that not all the sons of men shall be destroyed through the mystery of all things which the watchers have spoken and have taught their sons. And the whole earth was defiled through the example of the deeds of Azazel: to him ascribe all sins. And Yahuah said to Gabri'al: "Go against the bastards (the product of a union between two different kinds of beings) and those cast off and against the children of fornication, and destroy the children of fornication and the children of the watchers from among men; lead them out and let them loose that they may destroy each other by murder; for their days shall not be long. And they will all supplicate you, but their fathers will secure nothing for them, although they expect an everlasting life, and that each one of them live five hundred years.

Enoch 15:8-10 And now the giants, who have been begotten from body and flesh, will be called evil spirits on earth, and their dwelling places will be upon the earth. Evil spirits proceed from their bodies; because they were created from above, their beginning and first basis being from the qodosh watchers, they will be evil spirits upon the earth, and will be called evil spirits.

Enoch 21:1-2 And I went to a place where not one thing took place. And I saw something terrible, no high heavens, no founded earth, but a void place, awful and terrible.

Cloning – A useful technique for mankind

Umer Nadeem April 21, 2016

Science has contributed to easing of humans' problems since its proper understanding in the early 19th century. Without scientific discoveries and breakthroughs the world we see today, the technological advancements, couldn't have been possible. One of the outcomes of the science that have increased the chances of survival of mankind on this planet is the cloning. Cloning is the process of creating the multiple copies of any living being or object exactly identical to the original parent.

Here's a question: Once everyone has changed their DNA, will cloning make that so much more simpler to be able to PICK who would be the better CLONE??

Synthetic biology

Humanity has always been blighted with inequality, injustice and suffering.
What if editing DNA is the solution to all this? What if life can be made
more efficient?

From Harry J. Bentham

The problem with this is the fact that it's NOT Humanity that's the problem, it's the People who insist on RULING HUMANITY – the quest for power and the LURE of what the adversary has to offer those who would turn away from Yahuah and engage in the adversary's lies. Editing YOUR DNA will NOT make you more efficient, but you will become a BETTER PAWN for the ADVERSARY!!!

The Greater Good: Genetic Research on Human Embryos

02/08/2016 12:58 pm ET | Updated Feb 08, 2016

The CRISPR/Cas9 gene editing tool hit the market in early 2012. Clustered Regularly Interspaced Short Palindromic Repeats, a mouthful condensed as CRISPR, is a defense mechanism through which bacteria combat viruses, in a battle of atomic proportions, by altering the genetic sequencing of the invasive virus.

We have in our hands technology that can finally refashion the genetic makeup of progeny. The potential behind gene editing research is far too great, to be held back by bans and moratoriums. Advanced gene editing techniques can benefit millions - its research, the authors conclude, is a moral imperative.

Isn't it always the way, that MAN thinks that anything they do is always better than what Yahuah has created. This is a "red herring" if you actually think that in order to make ourselves better we need to "edit" our genes - always remember who's doing the editing and to what purpose. Better yet, think about who is actually responsible for ALL the diseases!!!

Scientists, Governments Re-Engineer Language to Sell Public on Embryo Re-Engineering

by REBECCA TAYLOR 02/01/2016

A recent headline in the United Kingdom's *Independent* shouts that the first genetically modified human embryos could be created in Britain in just a few weeks.

The article by Steve Connor reports that scientists have submitted a proposal to the Human Fertilization and Embryology Authority (HFEA), the government's fertility regulatory body, asking to edit the genes of "leftover" IVF embryos to try to treat infertility. Just today it was announced that the researchers have been given permission to move forward.

In 2001, alongside Cohen, as many as eight other IVF clinics were offering cytoplasmic transfer to their patients.

Cohen described the technique as "the first case of human ... genetic modification resulting in normal, healthy children."

These are the genetically modified babies who are now graduating from high school. Two of them are confirmed with genetic testing to have genetic material not from their parents.

It remains to be seen how "normal" and "healthy" these children are, since they haven't reached adulthood or had children of their own. We do know that two of the fetuses had Turner's syndrome, one miscarried and the other was aborted, and one child was diagnosed with "pervasive developmental disorder" at 18 months of age.

Forget Glass, Google patents 'cyborg' smart vision correcting system that is implanted into your EYEBALL

System would completely replace a patient's natural lens

Has sensors and wireless communication capabilities built in

Would help focus light onto the eye's retina

By Mark Prigg For Dailymail.com

Published: 15:26 EST, 29 April 2016 | Updated: 02:16 EST, 1 May 2016

<http://www.dailymail.co.uk/sciencetech/article-3566408/Forget-Glass-Google-patents-vision-correcting-gadget-implanted-EYEBALL.html>

HOW IT WOULD WORK

The device would be injected into a specially developed fluid that then solidifies to fuse the device with the eye's lens capsule, the transparent membrane surrounding the lens.

It would get power wirelessly via an antenna

The electronic lens would assist in the process of focusing light onto the eye's retina.

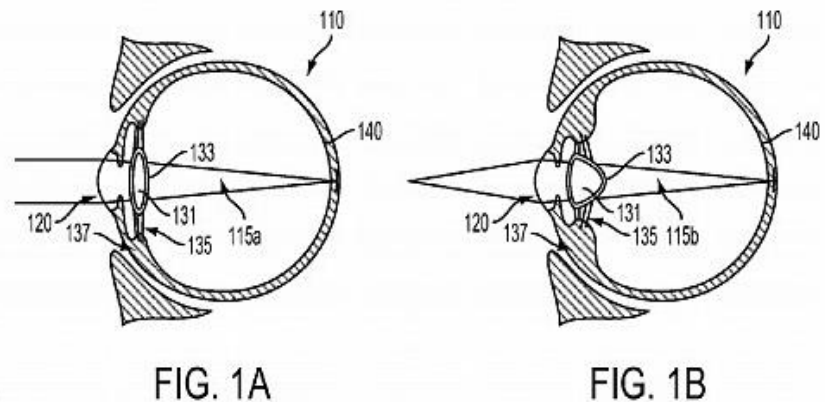

© USPTO

The smart vision correction system, complete with sensors and wireless communication, would help focus light onto the eye's retina.

Google is also developing smart lenses for diabetics, and last year signed a deal with health giant Novartis to produce its groundbreaking smart contact lenses.

The two will first produce a glucose monitoring lens for diabetics and one to treat farsightedness, it was announced at the time.

The firm has also hinted at 'other uses' for the technology - and has recently patented a lens with a built in camera.

Our dream is to use the latest technology in the miniaturization of electronics to help improve the quality of life for millions of people,' said Sergey Brin, Co-Founder of Google.

They start with something saying it will be GOOD – give you a better quality of life, and then.....hints at the other applications, which is a euphemism for “military application”. Check out what “WI-FI” actually does to the body, and don’t be fooled by the cell towers and other energy sources — electro-magnetic waves are BAD for the body!!!

KEY TO ETERNAL LIFE? Someone already born will 'live to 1,000 and immortality IS possible'

A DOCTOR who has dedicated his work to the quest for eternal life insists the record for the oldest living person will soon fall and someone already alive will keep going until they make 1,000.

By Jon Austin

PUBLISHED: 04:21, Sun, May 1, 2016 | UPDATED: 08:56, Sun, May 1, 2016

<http://www.express.co.uk/news/science/665807/KEY-TO-ETERNAL-LIFE-Someone-already-born-will-live-to-1-000-and-immortality-IS-possible>

British-born Mr de Grey, who graduated from Cambridge University in 1985 insists he is one of very few scientists looking at preventing, rather than slowing down ageing, and is perplexed why there is not huge focus on it.

He told the actuary.com: "To me, ageing was the world's most important problem. It was so obvious that I never tested the assumption. I always presumed that everyone else thought the same." He said: "People have this crazy concept that ageing is natural and inevitable, and I have to keep explaining that it is not.

"The human body is a machine with moving parts and like a car or an aeroplane, it accumulates damage throughout life as a consequence of normal operation."

[Mr de Grey is the co-founder and chief science officer of Strategies for Engineered Negligible Senescence \(SENS\) Research Foundation in California, USA,.](#)

"By reconstructing the structured order of the living machinery of our tissues, these rejuvenation biotechnologies will restore the normal functioning of the body's cells and essential biomolecules, returning aging tissues to health and bringing back the body's youthful vigor."

There was once the ability for "man" to live FOREVER, but that didn't happen because that man thought he could disregard what the Creator had told him to do to be able to enjoy that "long" life. This is nothing more than yet another attempt at "changing" the human DNA, and anything that does that makes the body a CHIMERA, you are NO longer part of Yahuah's creation!

Think carefully about that before you decide that this is a good thing, immortality is given by the Father as a gift for you following HIS way and instructions while you are in this LIFE!!!

Dead could be brought 'back to life' in groundbreaking project

<http://www.telegraph.co.uk/science/2016/05/03/dead-could-be-brought-back-to-life-in-groundbreaking-project/>



Scientists believe that a combination of therapies could stimulate regeneration CREDIT: GETTY

A biotech company in the US has been granted ethical permission to recruit 20 patients who have been declared clinically dead from a traumatic brain injury, to test whether parts of their central nervous system can be brought back to life.

The trial participants will have been certified dead and only kept alive through life support. They will be monitored for several months using brain imaging equipment to look for signs of regeneration, particularly in the upper spinal cord - the lowest region of the brain stem which controls independent breathing and heartbeat.

Dr Ira Pastor, the CEO of Bioquark Inc. said: "This represents the first trial of its kind and another step towards the eventual reversal of death in our lifetime.

"We hope to see results within the first two to three months."



Scientists smash record for human embryos grown in the lab in revolutionary breakthrough

Human embryo survives outside the womb for 13 days – about twice the previous record – heralding a new dawn in scientists' understanding of how life begins but triggering a fresh ethical debate

<http://www.independent.co.uk/news/science/human-embryos-grown-lab-test-tube-ivf-fertility-genetic-diseases-disability-medical-ethics-a7013656.html>

Since scientists first fertilised an embryo in a test tube in 1969, they have never managed to keep one alive for long after the point at which the foetus implants in the womb, normally about seven days.

However researchers at Cambridge University have now grown embryos for 13 days -- a process they only stopped to avoid breaking the current legal limit of about 14 days.

In Search For Cures, Scientists Create Embryos That Are Both Animal And Human

May 18, 2016 - 2:08 PM ET

A handful of scientists around the United States are trying to do something that some people find disturbing: make embryos that are part human, part animal. The researchers hope these embryos, known as chimeras, could eventually help save the lives of people with a wide range of diseases. One way would be to use chimera embryos to create better animal models to study how human diseases happen and how they progress. Perhaps the boldest hope is to create farm animals that have human organs that could be transplanted into terminally ill patients.

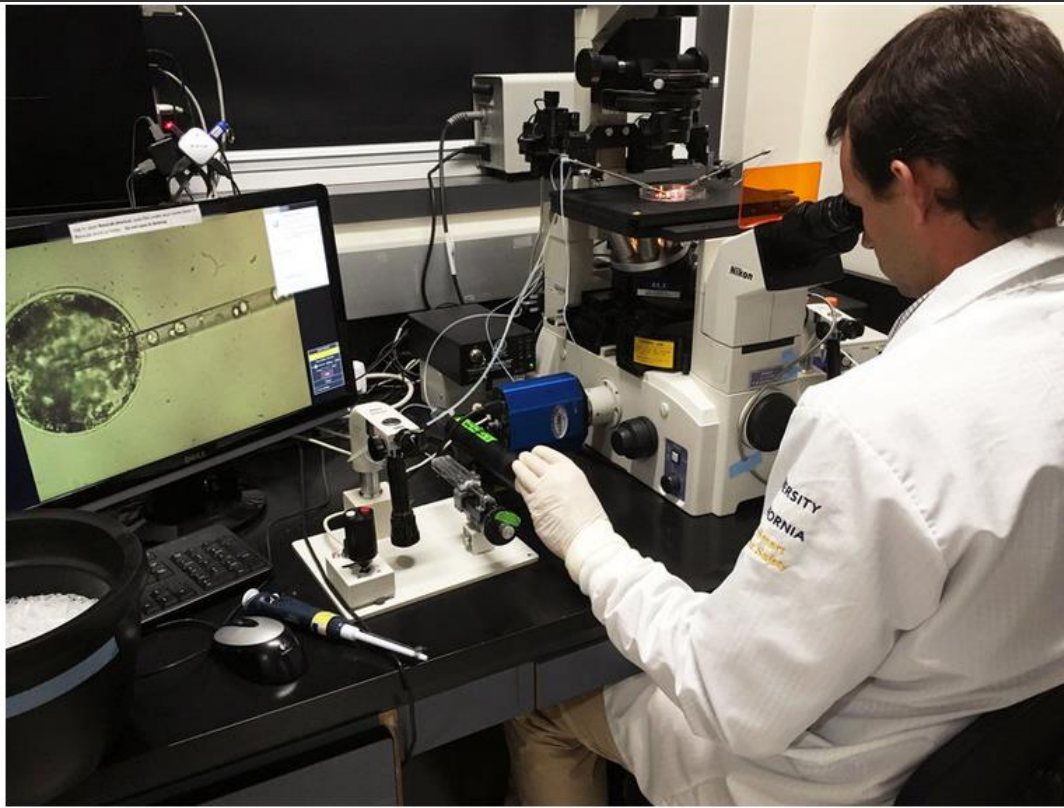

Pablo Ross of the University of California, Davis inserts human stem cells into a pig embryo as part of experiments to create chimeric embryos.

The day Ross opened his lab to me, a surgical team was anesthetizing an adult female pig so surgeons could make an incision to get access to its uterus. Ross then rushed over with a special syringe filled with chimera embryos. He injected 25 embryos into each side of the animal's uterus. The procedure took about an hour. He repeated the process on a second pig.

The uncertainty is part of what makes the work so controversial. Ross and other scientists conducting these experiments can't know exactly where the human stem cells will go. Ross hopes they'll only grow a human pancreas. But they could go elsewhere, such as to the brain.

"If you have pigs with partly human brains you would have animals that might actually have consciousness like a human," Newman says. "It might have human-type needs. We don't really know."

That possibility raises new questions about the morality of using the animals for experimentation. Another concern is that the stem cells could form human sperm and human eggs in the chimeras.

"If a male chimeric pig mated with a female chimeric pig, the result could be a human fetus developing in the uterus of that female chimera," Newman says. Another possibility is the animals could give birth to some kind of part-human, part-pig creature.

<http://www.npr.org/sections/health-shots/2016/05/18/478212837/in-search-for-cures-scientists-create-embryos-that-are-both-animal-and-human>

Don't be fooled that they have your health at heart – Yahuah gave us a way to live eternally, and it doesn't involve having animal parts in our being!!! Turning into a chimeric human is NOT the avenue to take!!

Man has been involved in **MAKING/CLONING/BUILDING** humans much longer than 1969 – we know the Germans during Hitler's time were doing everything they could to find the secret to life, immortality, time-travel, weapons, and demons. We know they found the demons and those demons are still with us today, but in the guise of **ALIENS** or lizards.... It's that search for a god-like status that give man that un-quenching thirst to try and defeat death. You can't blame Hawa (Eve) for this type of blasphemy against Yahuah!!!

Luring and lying is what the Adversary does best. You give up your soul for something you think you want and then you have to pay the piper so to speak. The Adversary **ALWAYS** expects repayment, not the case with Yahuah, who lets you keep your **FREE-WILL**, which is still **YOUR** greatest gift. Use it wisely, or you won't **KEEP IT!!!**

<http://donaldmarshallrevolution.com/#secretcloning>

Secret Human Cloning



What the public did not realize at the time, according to Illuminati whistleblower, Donald Marshall, was the fact that top-secret experiments in human cloning had already been conducted for many decades in deep underground military bases around the world. Marshall claims to have seen human cloning first hand, as an unwilling participant in human cloning since early childhood. Marshall says that elite scientists in every country all over the world use top-secret cloning technology to create identical human clones to be used in a variety of ways. These near perfect look-alikes can be used as stand-ins for top government leaders and elected officials, or sent to perform secret spy missions and dangerous acts of espionage.

Marshall further explains that there are many kinds of cloning technology used to grow different types of clones.

In replication cloning, top-secret scientists create the ideal conditions in the lab for new life to grow, resulting in a perfectly formed baby clone. However, this process is time-consuming, as the baby clone will still need to grow and develop as any other human baby. Instead, duplication cloning is preferred, whereby manipulating certain gene mutations, clone bodies can be quickly grown to full maturity in a matter of months, and can be used immediately.

The image features the official Seal of the President of the United States, centered on a blue gradient background. The seal is circular, with an outer ring containing the text "SEAL OF THE PRESIDENT OF THE UNITED STATES" in a serif font. Inside this ring is a bald eagle with its wings spread, holding an olive branch in its right talon and a bundle of arrows in its left. A shield with thirteen vertical stripes is on the eagle's chest. Above the eagle's head is a constellation of thirteen stars. Overlaid on the center of the seal is the text "WHITEHOUSE TV FEED" in a white, serif font with a slight drop shadow.

WHITEHOUSE
TV FEED

Setting in the
make-up chair



Out of the make-
up chair



Reptilian Hybrid Gets Mad On Dating Show & Shapeshifts - ALIEN SHAPESHIFTING

<https://www.youtube.com/watch?v=VDSPelmdaAM>







Bush Senior Eye Shift in Super Slow Motion

<https://www.youtube.com/watch?v=fmnTXhm2lts>

Reptilian Shapeshifters Hillary Clinton
<https://www.youtube.com/watch?v=IXSBVMv2Nn8>



Morphing along side of eye socket

Scaly/segmented eyelids

**Slit pupils, non-circular (angular/polygonal)
irides and pink sclerae**



Teeth morphing
**Corner of mouth expanding, pulling
back and upward into cheek**
"Joker's mouth"



A woman with blonde hair is speaking into a microphone. She is wearing a patterned top. The background is dark and out of focus. A text overlay is present on the left side of the image.

Teeth often demonstrate fluid-like behavior while morphing, appearing to drip or meld into each other, sometimes with threads forming between them, as seen here.

A close-up photograph of a woman with blonde hair speaking into a microphone. A white circle highlights the corner of her mouth, where the teeth are visible. The background is dark and out of focus.

Morphing at the corner of the mouth again, including the teeth. Note the absence of an upper human lip.



The irides keep changing color from frame to frame. In this instant, the right one is green and the left one is hazel/brown.

"Ordinarily", when she's relatively stable in human form, her eyes are blue, as seen on the left. Even so, she's still morphing slightly on the hand and neck in that picture.



<https://www.youtube.com/watch?v=nnWP52FWCS8>



Was Obama Replaced?









SPECIES - MICHELLE OBAMA - WHITE-EYED REPTILIAN
<https://www.youtube.com/watch?v=eeqfaW7QH7o>









Dulce Base in New Mexico is one of the deep underground bases:

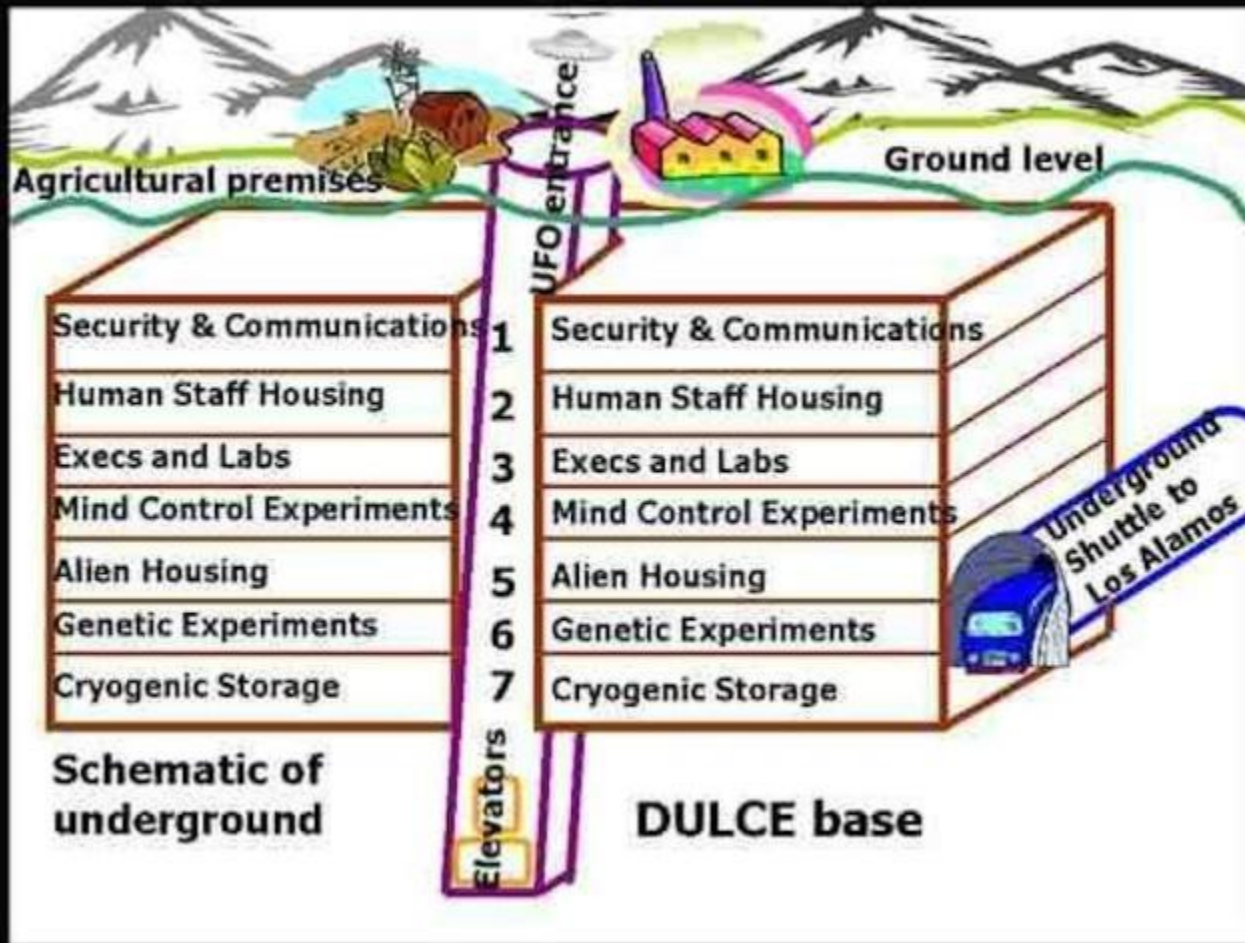

The Dulce underground secret base is purportedly under Mt. Archuleta near Dulce, New Mexico. This is supposedly the largest Reptilian and Grey base in America where there are allegedly atomic manipulation, cloning, studies of the human aura, advanced mind control applications, animal/human crossbreeding, visual and audio human chip implantation, abduction and feeding off of humans

<http://beforeitsnews.com/blogging-citizen-journalism/2013/03/dulce-underground-alien-base-smuggled-footage-2446294.html>



Here's a Youtube that you can watch:
<https://www.youtube.com/watch?v=IDoQDixfhxk>

This footage has allegedly been smuggled out from the Dulce alien underground base where humans and aliens work together on horrific bio genetic experiments this mind blowing new footage leaves many questions unanswered you can see a vast hall of cryo genetic feeding tanks and vats. Each of these tell a confusing, disturbing story of human / alien interaction in the top secret Human alien hybrid breeding programs



**TRANSGENIC/GLOWING
RABBIT**





WWW.TALIFORGOD.COM

YouTube: NEPHTALI1981



**GENETICALLY MODIFIED ANIMALS WITH
HUMAN ORGANS GROWN IN
ARTIFICIAL WOMBES**

<http://www.dailymail.co.uk/sciencetech/article-3589785/Secret-meeting-150-scientists-considers-creating-synthetic-human-genome-decade-experts-warn-technology-lead-arms-race.html>

Secret meeting of 150 top scientists considers creating synthetic human genome within a decade as experts warn technology could lead to an 'arms race'
150 people met to discuss the idea of creating synthetic human genome
This means using chemicals to build all of DNA found in chromosomes
Project's organizers say this would mainly aim to improve DNA synthesis
But, some argue that implications are too great to be discussed in secret

This means scientists would chemically recreate the genetic material that's naturally passed from parents to children.



DEMAND FOR THE HUMAN GENOME

The human genome consists of roughly 3 billion DNA base pairs.

There are four nucleotide bases found in DNA: adenine (A), cytosine (C), guanine (G), and thymine (T).

Critics of the synthesized human genome argue that advocates of this concept are presenting a challenge to scientists in order to drive demand, and reduce the cost of printing DNA fragments.

Currently, it would cost \$90 million to build the human genome, which is made up of three billion base pairs.

With the right demand, they say this could drop to just \$100,000.

It's always about money – but even more perplexing is this “DEMAND” for the human genome. As they say with the right DEMAND, the price would drop. Making it all the easier to be able to “make people”, but then don't they already do that? The misconception is that man can DUPLICATE what Yahuah has made by making a “synthesized genome”. Remember that “JUNK DNA” they can't figure out?? If you don't have that, you can't make a human!!!

ARTIFICIAL INTELLIGENCE

Artificial intelligence seem more like an oxy-moron than anything else. If the definition of intelligence is the ability to acquire and apply knowledge and skills, and the definition of artificial is made or produced by human beings rather than occurring naturally, typically as a copy of something in nature, then isn't the "copy" only as good as the "maker"?

After all, there have been many recalls on things that humans have made, but nothing that Yahuah has created!!

<http://futurism.com/artificially-intelligent-lawyer-ross-hired-first-official-law-firm/>

Artificially Intelligent Lawyer “Ross” Has Been Hired By Its First Official Law Firm

Law firm Baker & Hostetler has announced that they are employing IBM’s AI Ross to handle their bankruptcy practice, which at the moment consists of nearly 50 lawyers. According to CEO and co-founder Andrew Arruda, other firms have also signed licenses with Ross, and they will also be making announcements shortly.

Ross, “the world’s first artificially intelligent attorney” built on IBM’s cognitive computer Watson, was designed to read and understand language, postulate hypotheses when asked questions, research, and then generate responses (along with references and citations) to back up its conclusions. Ross also learns from experience, gaining speed and knowledge the more you interact with it.

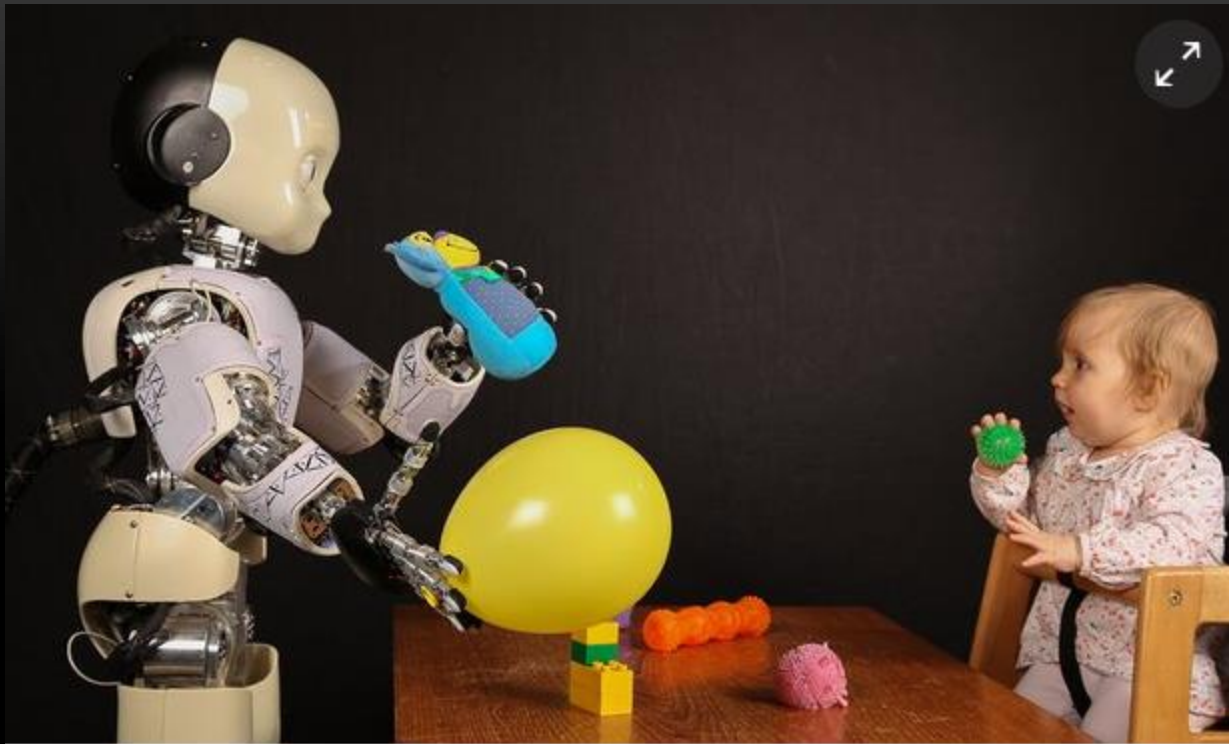

An iCub robot learns how to play from a child. Photograph: Dr Patricia Shaw/EP SRC/PA

AI will create 'useless class' of human, predicts bestselling historian

<https://www.theguardian.com/technology/2016/may/20/silicon-assassins-condemn-humans-life-useless-artificial-intelligence>

The doomsday story of an evil AI has been told a thousand times. But our fate at the hand of clever clogs robots may in fact be worse - to summon a class of eternally useless human beings.

At least that is the future predicted by Yuval Noah Harari, a lecturer at the Hebrew University in Jerusalem, whose new book says more of us will be pushed out of employment by intelligent robots and on to the economic scrap heap.

Sexy Robot Apocalypse? Robots Can Now Mate and Reproduce

TOPICS: 3D Printing Artificial Intelligence Joshua Krause Robots

June 2, 2016

<http://www.activistpost.com/2016/06/sexy-robot-apocalypse-robots-can-now-mate-and-reproduce.html>

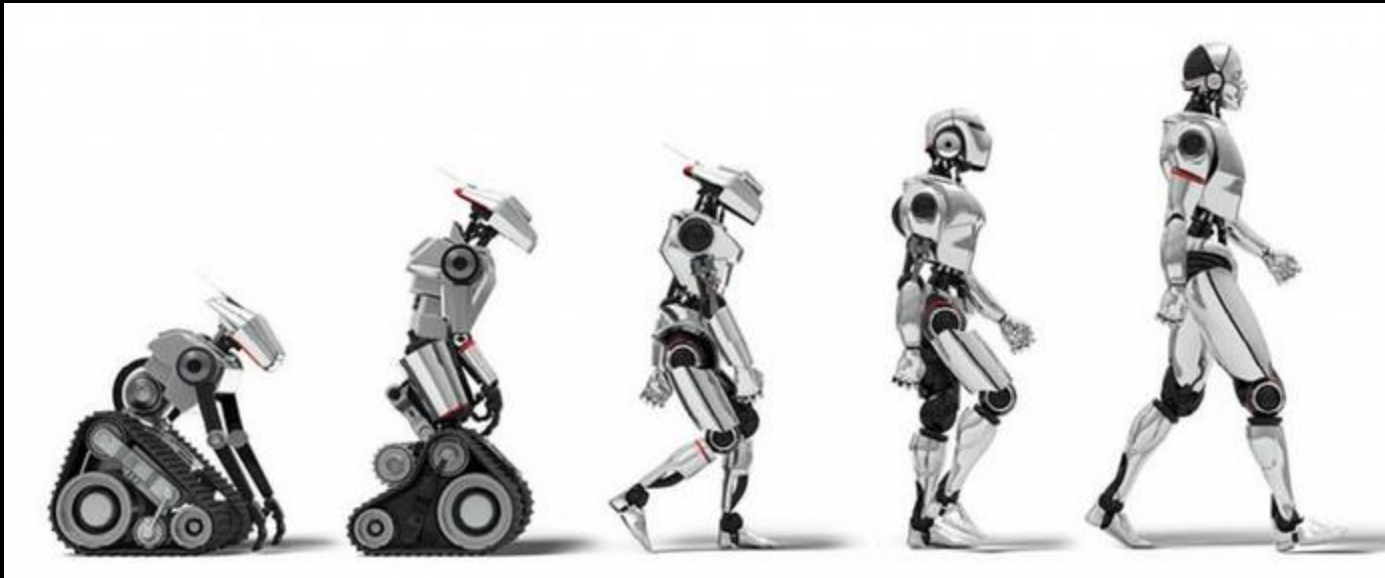

These days everyone is talking about automation, and how robots may take millions of our jobs over the next 20 years. By some estimates, this new wave of automation could wipe out nearly half of the jobs that exist today, and what will replace them isn't exactly clear. The rapid advance of digital technology has spawned an existential crisis in the workforce of the developed world.

However, robots that work for other humans are just the tip of the iceberg. There are all kinds of ways that robots could drastically change life for humans, and not in a good way. If anything, the robots that are coming to our workplaces are pretty tame compared to some of the stuff we're going to see in the near future. Buckle up, because the following is pretty weird.

Researchers in Amsterdam recently created robots that can 'mate' and create offspring in a roundabout way. Each robot is programmed with a genome that determines their software and hardware. They can communicate with each other through WiFi, and combine that information randomly to create a new genome, which is then sent to a 3D printer. Thus, a new robot is born in a way that resembles evolution in nature. So what could be so advantageous about teaching robots to reproduce themselves in this manner?

In the Robot Baby Project at Vrije Universiteit Amsterdam, scientists have developed a way for robots to have 'sex' and pass on their DNA to offspring.

Doing this can allow them to 'develop their bodies through evolution,' making for successive generations that have more advanced physical and behavioral capabilities.

As the process continues, the researchers say robots can become more suitable for use in unknown environments that could be hazardous to humans, like deep sea mines or even other planets.

Robots to Breed with Each Other and Humans by 2045

It would be easy to just keep going on with this study since each new day brings some new thing that they have invented.

It's your choice to decide to take man's stuff to change your DNA, taking your further and further from Yahuah and instead becoming a chimeric beast.

Don't be fooled when they say they can make you immortal – that's just more lies propagated by the adversary to make you think that he is a creator!!

There is only one Creator, Yahuah and there is only one Plan to obtain immortality and live in the Kingdom of Yahuah and Yahusha. That is the TORAH – the steps for our journey!!!

Yahuah has His plan for the adversary and his minions, don't find yourself in that company!!!

Enoch 45:2-6 They shall not ascend to heaven, and they shall not come on the earth. Such shall be the lot of the sinners who have denied the name of Yahuah of spirits, who are preserved for the day of suffering and tribulation. On that day My Elect One shall sit on the throne of honor and shall try the works of the righteous, and their places of rest shall be innumerable. And their souls shall grow strong within them when they see My Elect One, and those who have called on My esteemed name. Then I will cause My Elect One to dwell among them. I will transform heaven and make it an eternal blessing and light, and I will transform the earth and make it a blessing, and I will cause My elect ones to dwell on it. And the sinners and evildoers shall not set foot on it. For I have seen and satisfied My righteous ones with peace and have caused them to dwell before Me, but for the sinners there is judgment impending with Me, so that I shall destroy them from the face of the earth.